

AQUAREA INSTALLATION GUIDE 1.2

MONOBLOC SOLUTIONS H & J GENERATION



Welcome

Thank you for selecting a Panasonic Aquarea Monobloc A2W Heat Pump. Panasonic has been manufacturing A2W (Air to Water) Heat Pumps since 1973 and have become synonymous with market leading performance, efficiency and reliability.

Panasonic Aquarea Monobloc heat pump comes as standard with the following items:

1. Heat Pump Controller
2. Circulating Pump
3. Expansion Vessel (for primary hot water)
4. Strainer (Filter)
5. Magnetic Filter (J Series)
6. Pressure Relief Valve
7. Bottom Mounting Rails
8. Built in Electric Backup Heater used for:
 - a. Additional output support, depending on design (if required)
 - b. Backup for DHW tank sterilisation operation (if required)
 - c. Heat Pump protection in cold periods (if required)
 - d. Assistance with defrost operation (if required)

By including the above components inside the Heat Pump, the Panasonic Aquarea is one of the most compact A2W heat pumps on the market. This reduces the number of additional components that would otherwise need to be purchased and installed inside the property. This makes it ideal for retrofit projects and equally beneficial to new builds, where internal space is limited. Due to the high quality mounting system of the compressor and subsequent suppression of noise transmission, Panasonic Monobloc units do not require flexible hoses to transition from the Heat Pump to the pipe work used in the installation.

This Installation Guide covers various installation layouts:

1. Direct Connection - Auto Bypass (Single Zone)
2. Hydraulic Separation - Low Loss Header (Single Zone)
3. Hydraulic Separation - Buffer Tank (Single Zone)
4. Hydraulic Separation - Pre Plumbed Cylinder with built in Buffer Tank (Single Zone)
5. Two Zone - Direct Flow Temperatures
6. Two Zone - 1 Zone Direct Flow , 1 Zone Mixed Flow Temperatures
7. Two Zone - Mixed Flow Temperatures
8. Bi-Valent (Hybrid) - Heat Pump & Boiler

Implementing the correct hydraulic layout with the coinciding controller setup, as detailed in this guide, will enable the Heat Pump system to operate efficiently and reliably. This makes for a smooth installation, a happy installer and a happy end user. The heating distribution design does not fall within the scope of this guide regarding the layout or individual controls. Layouts are for indication purpose only and Panasonic accept no liability covering designs.

This installation guide does not replace the Installation Manual or Service Manual, which both provide more in-depth guidance to installation requirements. Installation/Service manuals can be downloaded directly from Panasonic Pro Club.

www.panasonicproclub.com

Contents

Aquarea Smart Cloud	4
Panasonic Pro Club	6
Outdoor Siting of Unit	7
Electrical Requirements	8
Primary Pipework (heating) Sizing Guide	8
Expansion Vessel (heating)	8
Flow Rates.....	8
Main Components (Single Fan Unit).....	9
Main Components (Twin Fan Unit).....	9
Installation Schematics.....	10
Auto Bypass Install.....	10
Low Loss Header.....	11
Buffer Tank.....	12
Pre-plumbed Duo Tank	13
Wiring	14
Remote Controller Simple Setup	15
Error Codes during Commissioning	31
Advanced Installations - 2 Zone Setup	34
Installation Schematics	35
Direct Flow Temperatures	35
Direct and Mixed Flow Temperatures	36
Both Mixed Flow Temperatures	37
2 Zone Wiring - Main PCB	38
2 Zone Wiring - Additional PCB	39
2 Zone Controller Setup	40
Operating 2 Zones	42
Mixing Valves	43
Wiring	45
Advanced Installations - Bi-Valent	46
Basic Layout	47
Independent Buffer Connection	47
Bi-Valent - Main PCB	48
Bi-Valent - Optional PCB	49
Bi-Valent Controller Setup	50
Smart Grid (SG) Bivalent Option for J Series	55
Accessories and Control	56
Warranty	57
Commissioning Sheets	63

Aquarea Smart Cloud for end users

The most advanced heating control for today and for the future. Aquarea can be connected to the Cloud with CZ-TAW1, enabling both end user control and remote maintenance by service partners.

WATCH DEMO ▶

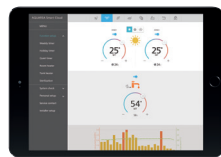
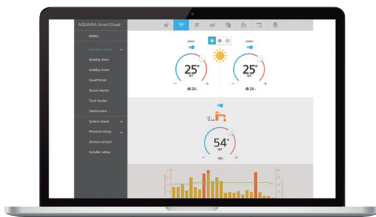

* User interface image may change without notification.

Easy and powerful energy management

The Aquarea Smart Cloud is much more than a simple thermostat for switching a heating device ON or OFF. It is a powerful and intuitive service for remotely controlling a range of heating and hot water functions, including monitoring energy consumption.

How does it work?

After connecting an Aquarea J or H generation to the cloud by wireless LAN or by wired LAN, the user accesses the Cloud portal to remotely operate various functions of their heat pump. They can also permit service partners to access personalised functions for remote maintenance and monitoring.

Requirements

1. Aquarea J or H Generation with either built in Wifi or with the CZ-TAW1 Wifi Module Accessory
2. In-house internet connection with router wireless LAN or wired LAN
3. A Panasonic ID, available from: <https://aquarea-smart.panasonic.com/>

Functions:

- Visualisation and Control
- Scheduling
- Energy Statistics
- Malfunction notification



More possibilities with IFTTT.
IF This Then That: IFTTT service enables user to automatically trigger actions for Aquarea system based on other apps, web services or devices.

Connect your Aquarea to your voice assistant, get an e-mail if your Aquarea gets an error or automatically turn on your Aquarea on Heat Mode when outdoor temperature drops below specified level.



https://ifttt.com/aquarea_smart_cloud

Advantages

Energy savings, comfort and control from anywhere. Increased efficiency and resources management, operating costs savings and owner satisfaction. The Aquarea Smart Cloud services are focused on enabling full remote maintenance of the Aquarea system. This allows maintenance specialists to engage in predictive maintenance and system fine-tuning, as well as fixing malfunctions when they occur.

Aquarea compatibility	J and H Generation
Connection point	CN-CNT Aquarea port
Home router connection	Wireless or Wired LAN
Temperature sensor	Can use remote controller sensor
Tablet or PC browser compatibility*	Yes
Operation from remote – ON/OFF – Temperature setting Mode selection – DHW setting – Error codes – Scheduling	Yes
Heating areas	Up to 2 zones
Power consumption estimation – Operation log history	Yes – Yes

* Check browsers and version compatibility.

Aquarea Service Cloud for Installers / Maintenance

WATCH DEMO



The real remote maintenance made simple

The Aquarea Service Cloud allows installers to take care of their customers' heating systems remotely. It saves time and money and shortens the response time, thus increasing the customers' satisfaction.

Advanced functions for remote maintenance with professional screens:

- Global view at a glance
- Error log history
- Full system information
- Statistics always available
- Most settings available

Home page.

Status of connected users at a glance. 2 view options: map view or list view.

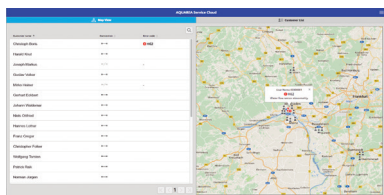

Status tab.

Current status of unit with a maximum 28 parameters.



Statistics tab.

Customisable statistics of a maximum of 73 parameters. Available anytime with the information of the last 7 days.



Settings tab.

Most of the user and installer settings can be done remotely.



Activation of the Aquarea Service Cloud

Requirements.

Hardware and connection	End user registration	Installer / maintenance registration
J or H Generation Aquarea connected to CZ-TAW1	Get Panasonic ID	Get Service ID
In-house internet connection with Wireless LAN or Wired LAN	Aquarea Smart Cloud	Aquarea Service Cloud

Connecting the unit to the Aquarea Service Cloud.

The process can be initiated by the end user or by the installer.

The end user can select and change the installer's level of control anytime (4 levels).

Installer registration: <https://aquarea-service.panasonic.com/>

End user registration: <https://aquarea-smart.panasonic.com/>

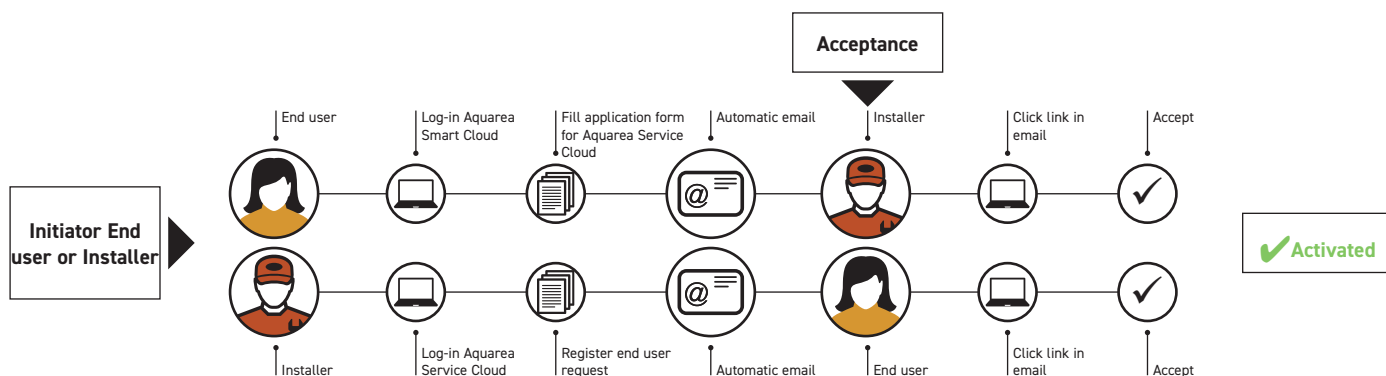

PRO Club. The professional website of Panasonic



This Installation Guide is to assist and supplement the installation of the Heat Pump system. If you require full Installation Instructions or Service Manuals please download these from Panasonic Pro Club.

Panasonic has an impressive range of support services for designers, specifiers, engineers and distributors working in the heating and cooling industry. Panasonic PRO Club is the online tool which makes your life easier! You just have to register and many useful tools and features are freely available to you, where ever you are, from your computer or smart phone!

Aquarea Designer

Panasonic provides bespoke software helping system designers, installers and dealers to very quickly design and size systems, create wiring diagrams and issue bills of quantities at the push of a button.

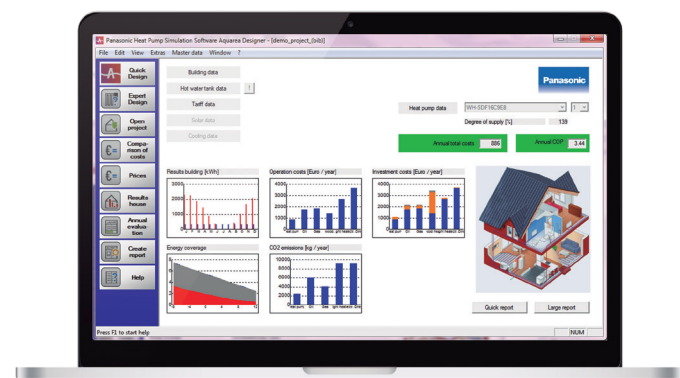

Panasonic helps you to calculate the system label

Since 26th September 2015, installers can be assured that all products manufactured after this date will be sold with the required ErP labels which will aid installers with their paperwork. While it is the manufacturer's responsibility to issue their products with the required labels, the installers will need to calculate and issue an efficiency label for the entire heating system. Whether installing a new heating system or installing new boilers, controls or renewables into an existing system, it is, and will continue to be, the installer's responsibility to calculate and issue efficiency labels. Calculators which assist installers with this process are available on the Panasonic Heating and Cooling Solutions website.



PRO Club  Download on www.panasonicproclub.com or connect simply with your smart phone to the PRO Club using this QR



Outdoor Siting of Unit

Providing the required clearance around the outdoor unit allows the system to operate properly, since this is the renewable input energy for the system (free air).

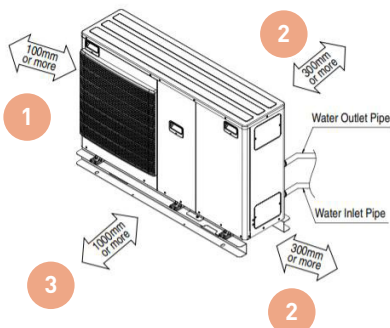

Clearance around unit required for operation. For Single & Twin fan units:

1. Minimum Distance 100mm
2. Minimum Distance 300mm
3. Minimum Distance 1000mm

If the unit is sited within 1 mile of a coastal area then ensure the unit is treated by Bronz-Glow or an equivalent treatment. Panasonic can provide this treatment at an additional cost prior to delivery of equipment.

Electrical Requirements - Single Phase

Power supply 1: supplies power to the PCB's Fan, Circulating Pump

Power supply 2: supplies power to Internal Backup heater and external DHW immersion booster heater if present and controlled by the Heat Pump. Ensure the cable, circuit breaker and isolator is suitably sized to accommodate the current drawn by the backup heater when it is set to its maximum potential of backup heater output (the kW is indicated by the number after the series letter "H" or "J" in model reference).

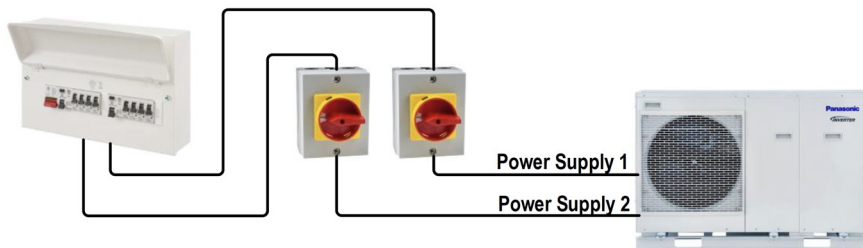

Model (single Phase)	Power Supply 1 (Compressor) Circuit Breaker Size	Recommended RCD	Power Supply 2 (BackUp Electric) Circuit Breaker Size	Recommended RCD Size
WH-MDC05J3E5	16A	30mA, 2P, type A	16A	30mA, 2P, type AC
WH-MDC07J3E5	25A	30mA, 2P, type A	16A	30mA, 2P, type AC
WH-MDC09J3E5	25A	30mA, 2P, type A	16A	30mA, 2P, type AC
WH-MDC12H6E5	30A	30mA, 2P, type A	30A	30mA, 2P, type AC
WH-MDC12J6E5	30A	30mA, 2P, type A	30A	30mA, 2P, type AC
WH-MDC16H6E5	30A	30mA, 2P, type A	30A	30mA, 2P, type AC
WH-MDC16J6E5	30A	30mA, 2P, type A	30A	30mA, 2P, type AC
WH-MXC09H3E5	30A	30mA, 2P, type A	30A	30mA, 2P, type AC
WH-MXC09J3E5	30A	30mA, 2P, type A	30A	30mA, 2P, type AC
WH-MXC12H6E5	30A	30mA, 2P, type A	30A	30mA, 2P, type AC
WH-MXC12J6E5	30A	30mA, 2P, type A	30A	30mA, 2P, type AC

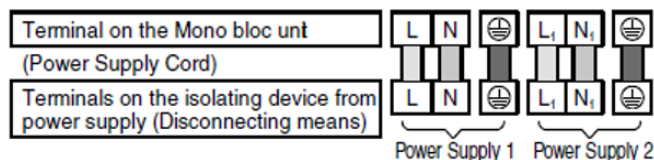

Electrical Requirements - Three Phase

Power supply 1: supplies power to the PCB's Fan, Circulating Pump

Power supply 2: supplies power to Internal Backup heater and external DHW immersion booster heater if present and controlled by the Heat Pump. Ensure the cable, circuit breaker and isolator is suitably sized to accommodate the current drawn by the backup heater when it is set to its maximum potential (maximum potential in kW for all three phase models is 9kW).

Model (three Phase)	Power Supply 1 (Compressor) Circuit Breaker Size	Recommended RCD	Power Supply 2 (BackUp Electric) Circuit Breaker Size	Recommended RCD
WH-MXC12H9E8	20A	30mA, 4P, type A	20A	30mA, 4P, type AC
WH-MXC12J9E8	20A	30mA, 4P, type A	20A	30mA, 4P, type AC
WH-MXC16H9E8	20A	30mA, 4P, type A	20A	30mA, 4P, type AC
WH-MXC16J9E8	20A	30mA, 4P, type A	20A	30mA, 4P, type AC

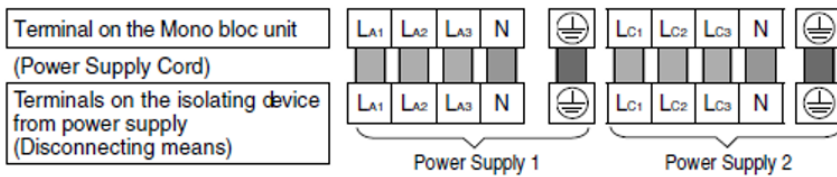

Primary Pipework (Heating) Sizing Guide

Correct sizing of pipework will allow the maximum energy generated by the unit (in kW) to be delivered to the distribution system. Under sizing will cause noisy pipe work and reduced output.

kW Output	Copper Pipe Size O/D (mm)*
5kW	22
7kW	22
9kW	28
12kW	28
16kW	35

Table of recommendations for pipework

If plastic pipe is used, then larger O/D size than indicated will be required, according to the model installed. (i.e. 9kW will be 35mm in plastic).

***Please note that these sizes are for guidance only and may differ dependant on pipe run, pressure losses within the system and number of bends.**

Expansion Vessel

Unit Type	Expansion Vessel Volume (Litres)	Maximum System Volume Before an Additional Expansion Vessel is required to be fitted (Litres)
Single Fan	6	150
Twin Fan	10	200

The expansion vessel is built into the outdoor unit and will accommodate the heating system only. The DHW expansion vessel will be supplied with the cylinder and fitted separately.

If the system volume is more than indicated in the table or has more than a 7m head height an additional expansion vessel will have to be fitted.

Flow Rates

kW output of unit	5	7	9	12	16
Flow rate (L/min)	14.3	20.1	25.8	34.4	45.9

The table indicates the required flow rates, which are necessary in order to deliver the stated capacity of the Heat Pump. Failure to achieve the required flow rate, will result poor efficiency and performance. A flow rate < 7 l/min (single fan) and < 11 l/min (twin fan) will cause the system to incur a H62 error.

Main Components (Single Fan Unit)

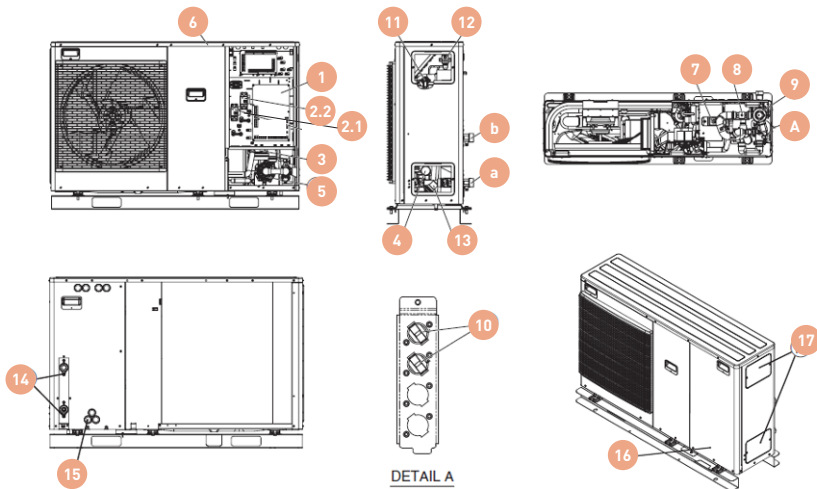

Component Name

1. PCB
- 2.1 Single Phase RCCB (Main Power)
- 2.2 Single Phase RCCB (Backup Heater)
3. Heat Exchanger
4. Water Pressure Gauge
5. Water Pump
6. Cabinet Top Plate
7. Expansion Vessel
8. Flow Sensor
9. Heater Assembly
10. Overload Protector
11. Pressure Relief Valve
12. Air Purge Valve
13. Strainer (+ magnetic filter for "J" series onwards)
14. Plug (2 Pieces)
15. Bushing (7 Pieces)
16. Cabinet Front Plate
17. Cover (2 Pieces)

Connector Name

- a. Water Inlet - 1 ¼" bsp
- b. Water Outlet - 1 ¼" bsp

Main Components (Twin Fan Unit)

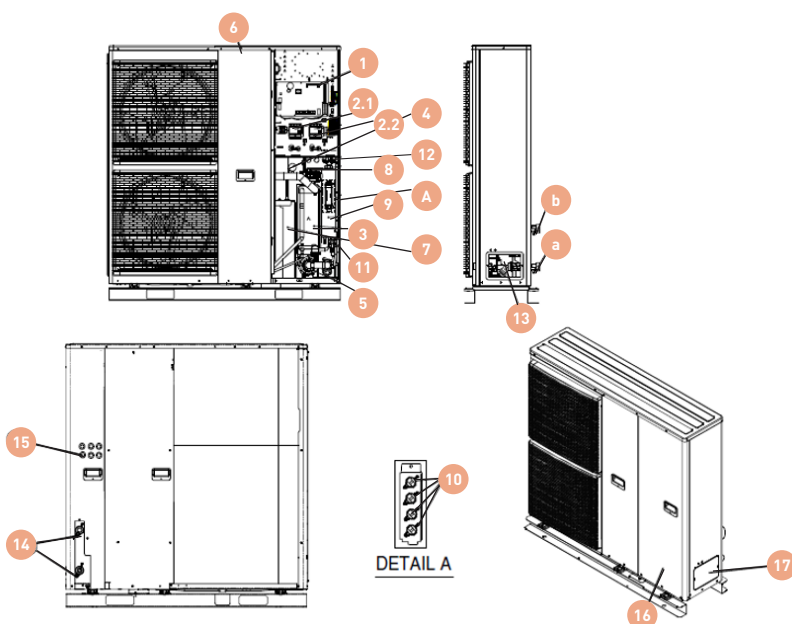

Component Name

1. PCB
- 2.1 Single Phase RCCB (Main Power)
- 2.2 Single Phase RCCB (Backup Heater)
3. Heat Exchanger
4. Water Pressure Gauge
5. Water Pump
6. Cabinet Top Plate
7. Expansion Vessel (Not Visible)
8. Flow Sensor
9. Heater Assembly
10. Overload Protector (4 Pieces)
11. Pressure Relief Valve
12. Air Purge Valve
13. Strainer (+ magnetic filter for "J" series onwards)
14. Plug (2 Pieces)
15. Bushing (6 Pieces)
16. Cabinet Front Plate
17. Cover

Connector Name

- a. Water Inlet - 1 ¼" bsp
- b. Water Outlet - 1 ¼" bsp

Installation Schematic

Auto Bypass Install:

This hydraulic installation would typically be used in a new build property, where no secondary circulating pump is installed and sufficient open water volume is present (to prevent short cycling). Circulation of primary heating water would be provided by the circulating pump within the Panasonic outdoor unit.

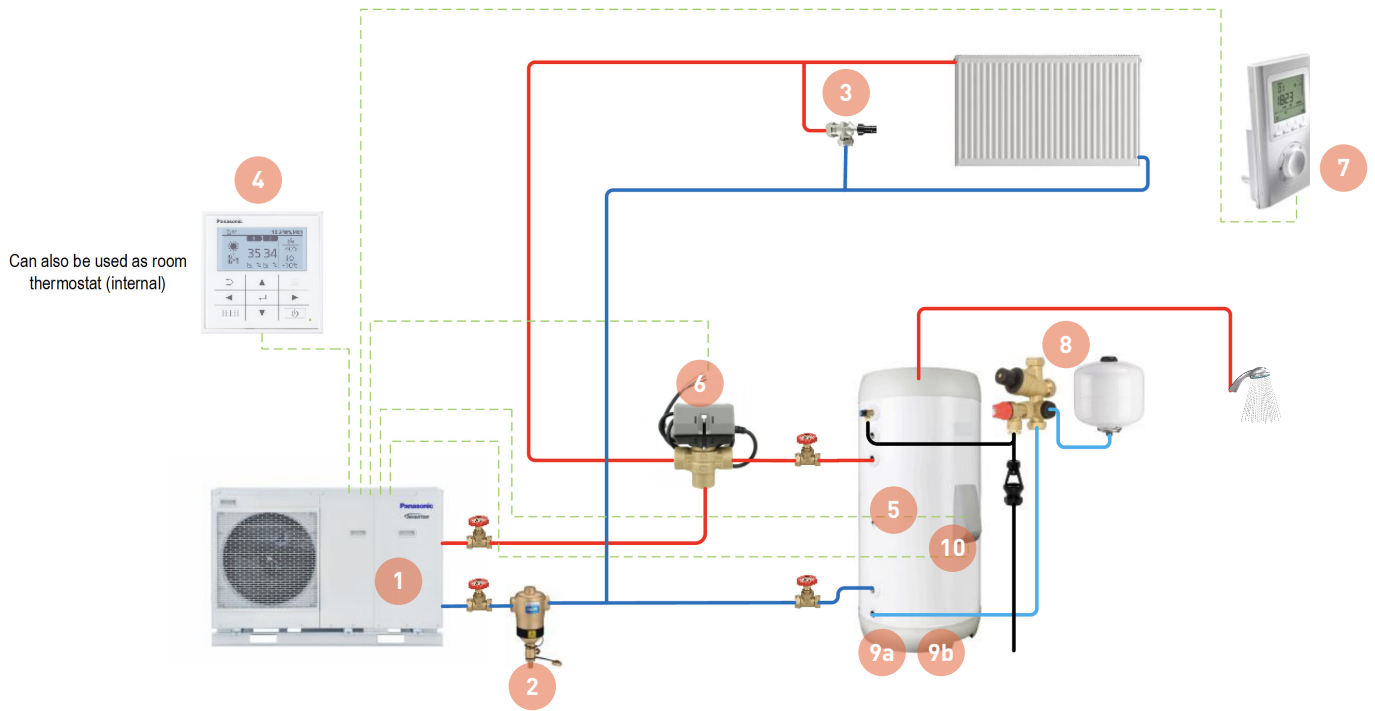

Number	Description	Type of Recommendation	Panasonic Part Number
1	Monobloc Unit	Mandatory	---
2	Magnetic Particle Filter	Mandatory on "H" Series Recommended on "J" Series*	---
3	Auto Bypass	Mandatory (field supplied)	---
4	Remote Controller	Supplied with Monobloc Unit	---
5	Tank Sensor	Supplied with a Panasonic DHW tank, if 3rd party tank used then has to be purchased separately (20m)	PAW-TS2
6	3 Way Valve	Mandatory if DHW tank installed	PAW-3WYVLV-HW
7	Room Thermostat (external)	Recommended (can be field supplied)	PAW-A2W-RTWIRED
8	G3 Kit	Mandatory (supplied with tank)	PAW-G3KIT
9a	200L DHW Cylinder	Mandatory if DHW is required	PAW-TD20C1E5-UK
9b	300L DHW Cylinder	Mandatory if DHW is required	PAW-TD30C1E5-UK
10	Immersion (Booster) Heater	Mandatory	---

*"J" series has a small inbuilt magnetic particle filter.

Installation Schematic

Low Loss Header:

A typical installation for Retrofit installations, where primary pipe work is interdependent of the distribution system. This means the primary and secondary sides are “hydraulically separated”. Both side of the system are unable to inhibit each others flow. The distribution pump must be installed on the outlet of the low loss header to avoid negative pressure through the system.

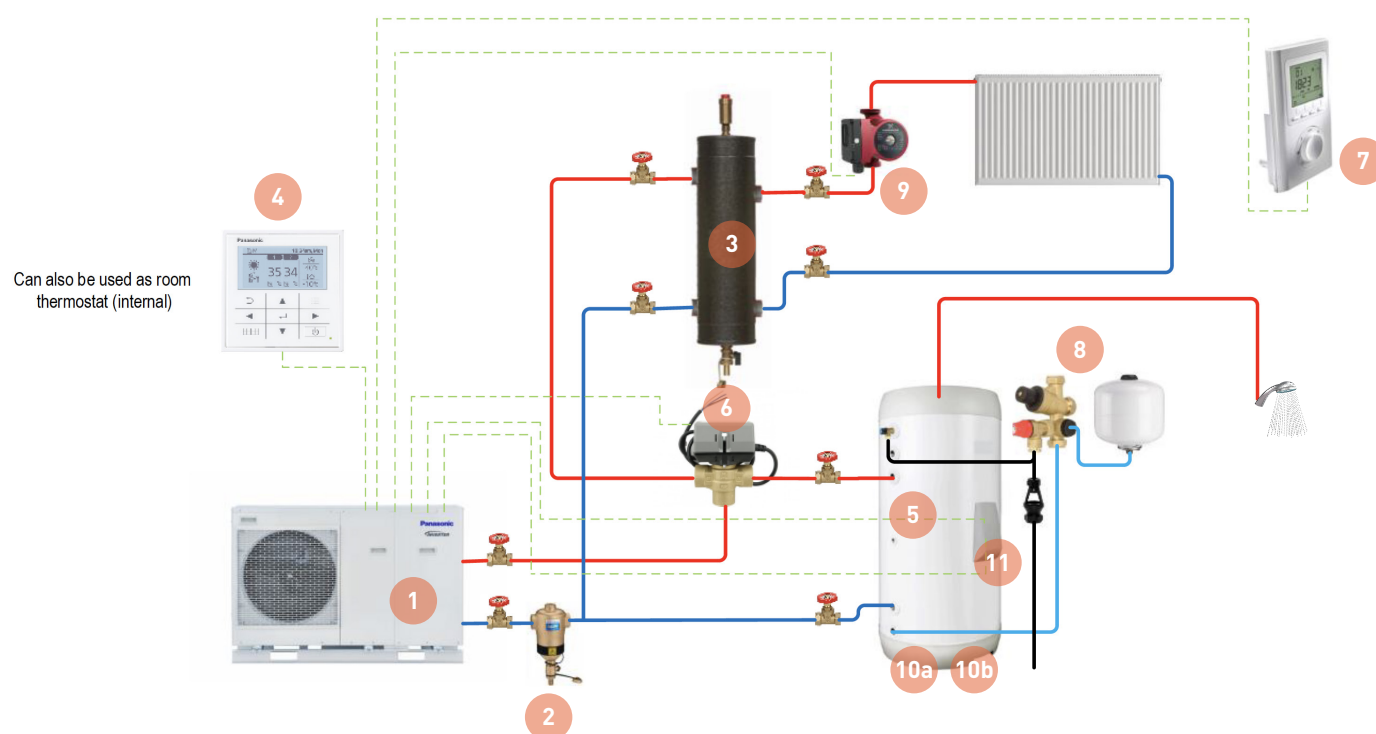

Number	Description	Type of Recommendation	Panasonic Part Number
1	Monobloc Unit	Mandatory	---
2	Magnetic Particle Filter	Mandatory on “H” Series Recommended on “J” Series*	---
3	Low Loss Header	Recommended (field supplied)	---
4	Remote Controller	Supplied with Monobloc Unit	---
5	Tank Sensor	Supplied with a Panasonic DHW tank, if 3rd party tank used then has to be purchased separately (20m)	PAW-TS2
6	3 Way Valve	Mandatory if DHW tank installed	PAW-3WYVLV-HW
7	Room Thermostat (external)	Recommended (can be field supplied)	PAW-A2W-RTWIRED
8	G3 Kit	Mandatory (supplied with tank)	PAW-G3KIT
9	Circulating Pump	Mandatory (field supplied)	---
10a	200L DHW Cylinder	Mandatory if DHW is required	PAW-TD20C1E5-UK
10b	300L DHW Cylinder	Mandatory if DHW is required	PAW-TD30C1E5-UK
11	Immersion (Booster) Heater	Mandatory	---

*“J” series has a small inbuilt magnetic particle filter.

Installation Schematic

Buffer Tank:

Using a Buffer tank is the ideal installation design. This allows the set up of heat pump circuit and heating circuit to operate at their optimum level of performance and efficiency. The buffer tank also provides open water volume between heat pump and heating circuit, which also helps reduce the stop/start cycles of the compressor. Where underfloor is connected, the volume stored allows a quicker response time. Stored volume also allows more efficient defrost cycles, without the need for direct electric backup support to be activated. This layout is highly advisable when the heating circuit is designed and installed by a 3rd party and therefore, also provides a definitive separation of liability for both parties. The buffer tank is a neutral point in the system. The distribution pump must be installed on the outlet to the heating system to avoid negative pressure.

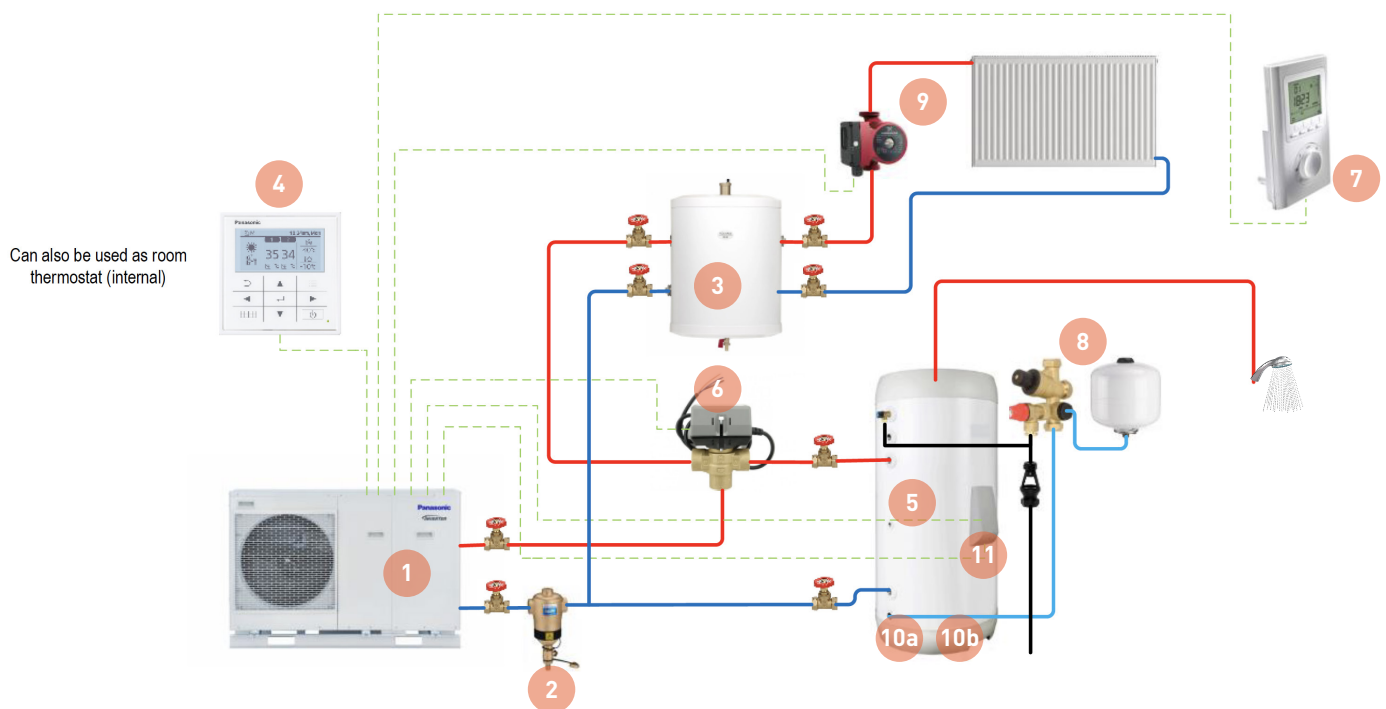

Can also be used as room thermostat (internal)

Number	Description	Type of Recommendation	Panasonic Part Number
1	Monobloc Unit	Mandatory	---
2	Magnetic Particle Filter	Mandatory on "H" Series Recommended on "J" Series*	---
3	Low Loss Header	Recommended (field supplied)	PAW-BTANK50L-2
4	Remote Controller	Supplied with Monobloc Unit	---
5	Tank Sensor	Supplied with a Panasonic DHW tank, if 3rd party tank used then has to be purchased separately (20m)	PAW-TS2
6	3 Way Valve	Mandatory if DHW tank installed	PAW-3WYVLV-HW
7	Room Thermostat (external)	Recommended (can be field supplied)	PAW-A2W-RTWIRED
8	G3 Kit	Mandatory (supplied with tank)	PAW-G3KIT
9	Circulating Pump	Mandatory (field supplied)	---
10a	200L DHW Cylinder	Mandatory if DHW is required	PAW-TD20C1E5-UK
10b	300L DHW Cylinder	Mandatory if DHW is required	PAW-TD30C1E5-UK
11	Immersion (Booster) Heater	Mandatory	---

*"J" series has a small inbuilt magnetic particle filter.

Installation Schematic

Pre-plumbed Duo Tank (Cylinder, Buffer tank , 3 port valve and associated pipework in one product):

This layout shows a cylinder, buffer tank & 3 port valve installation using the Panasonic designed pre-plumbed cylinder/ buffer Duo tank, the benefit of the pre-plumbed Panasonic Duo not having to find space for buffer tank. Along with the 3 port valve and associated pipework being pre-plumbed, this product saves time and makes for an all round more compact looking installation.

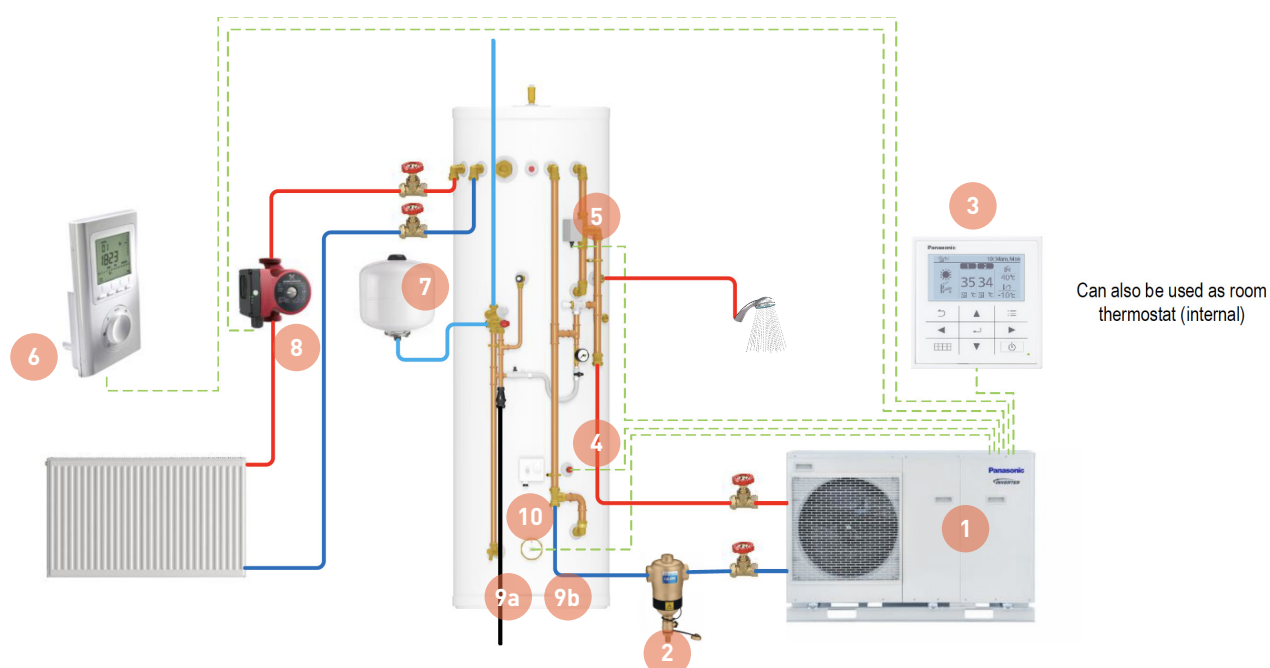

Number	Description	Type of Recommendation	Panasonic Part Number
1	Monobloc Unit	Mandatory	---
2	Magnetic Particle Filter	Mandatory on "H" Series Recommended on "J" Series*	---
3	Remote Controller	Supplied with Monobloc Unit	---
4	Tank Sensor	Supplied with a Panasonic DHW tank, if 3rd party tank used then has to be purchased separately (20m)	PAW-TS2
5	3 Way Valve	Mandatory if DHW tank installed	PAW-3WYVLV-HW
6	Room Thermostat (external)	Recommended (can be field supplied)	PAW-A2W-RTWIRED
7	G3 Kit	Mandatory (supplied with tank)	PAW-G3KIT
8	Circulating Pump	Mandatory (field supplied)	---
9a	200/70L DHW/Buffer Cylinder	Mandatory if DHW is required	PAW-TD20B7PP-UK
9b	300/70L DHW Buffer Cylinder	Mandatory if DHW is required	PAW-TD30B7PP-UK
10	Immersion (Booster) Heater	Mandatory	---

*"J" series has a small inbuilt magnetic particle filter.

Wiring

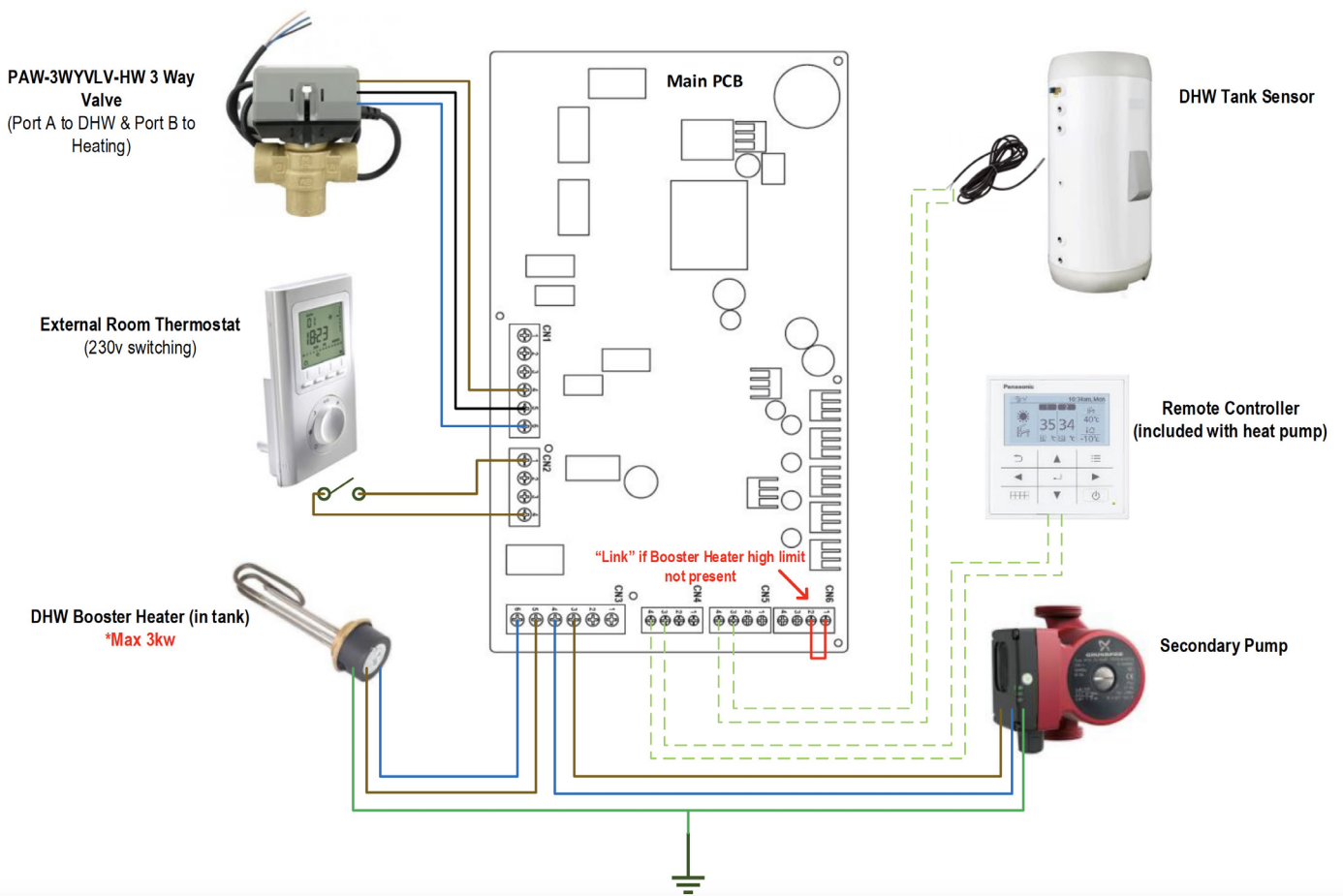

Please check the following before commencing start up.

- Check all electrical wiring and connections
- Make sure all auto air vents are open and the pressure relief valves are closed
- Make sure the system is filled with the correct fluid to around 2 Bar (minimum 1.5 Bar).
- Check the expansion vessel is large enough for the system (see page 8).
- Check all fuses and circuit breakers.
- Check that Primary Pipework (heating) is sized correctly for the unit installed (see page 8) to ensure the flow rate required can be achieved. (If the flow rate is too low, the system will not operate).
- In Monobloc heat pumps, the water goes outside the building. The unit can protect itself against freezing up, but if the power goes off, there is a risk that the unit will freeze and cause damage. To prevent this, we recommend putting a propylene glycol mixture in the system. It is important that the glycol concentration is adequate to protect the unit. If the unit freezes up, the warranty will become void. See full warranty terms and conditions for more details.

Remote Controller Simple Setup

- Buttons / Indicator**
- 1 Quick Menu Button**
(For more details, refer to the separate Quick Menu Guide.)

 - 2 Back button**
Returns to the previous screen

 - 3 LCD Display**

 - 4 Main Menu button**
For function setup

 - 5 ON/OFF button**
Starts/Stops operation

 - 6 Operation indicator**
Illuminates during operation, blinks during alarm.

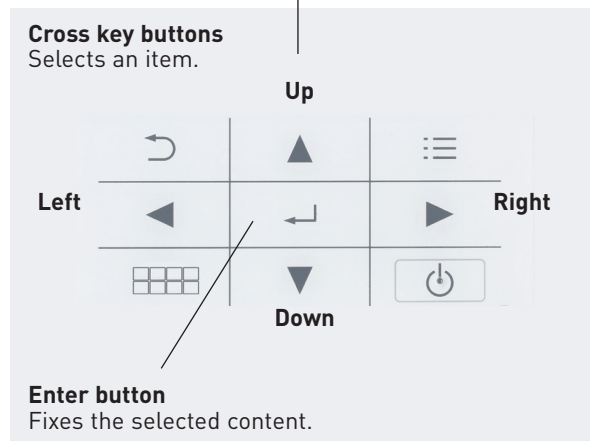
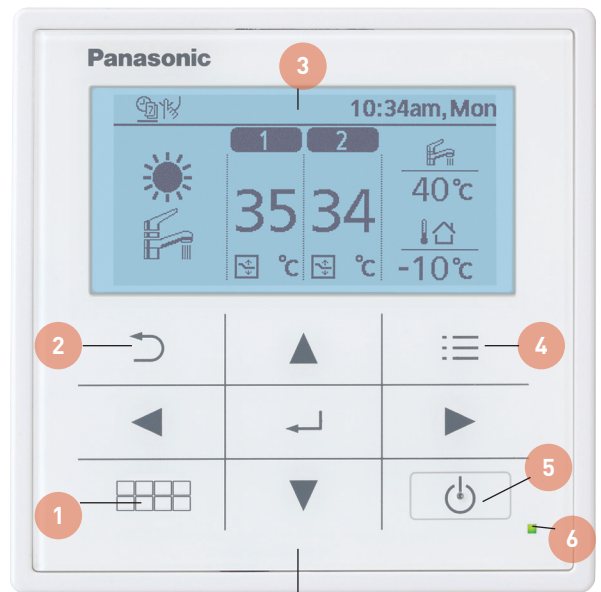

Step 1: Initial Setup

When the heat pump is powered up for the first time, the remote controller will automatically enter the initial settings screen. **Set the user language and the time & date:**

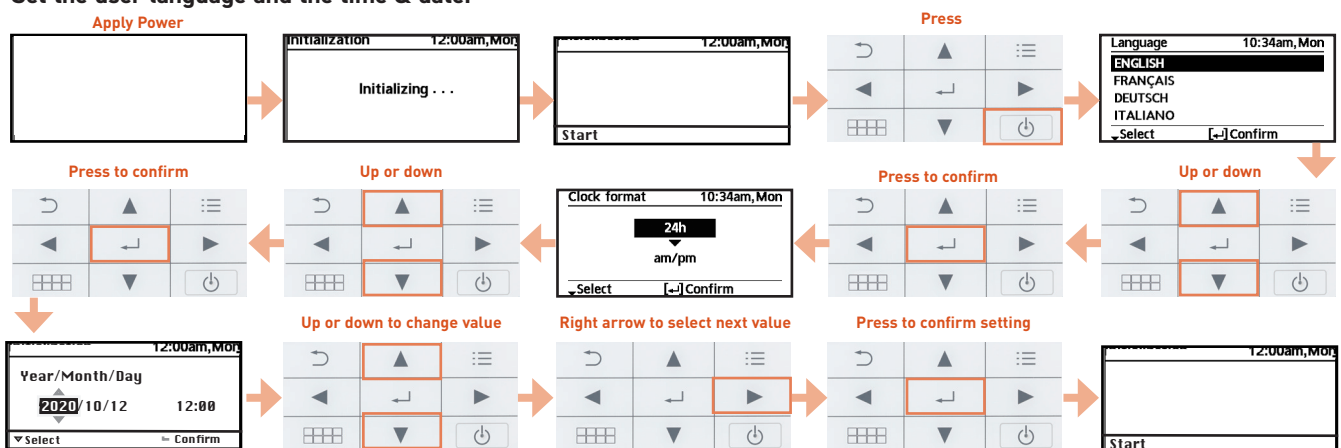

Do not press at this stage. The controller must remain off (LED in bottom right hand corner will be off).

Step 2: Air purge & set max pump speed

a) Switch on “Air Purge” to run the circulating pump: This will help fill and vent the heating system.

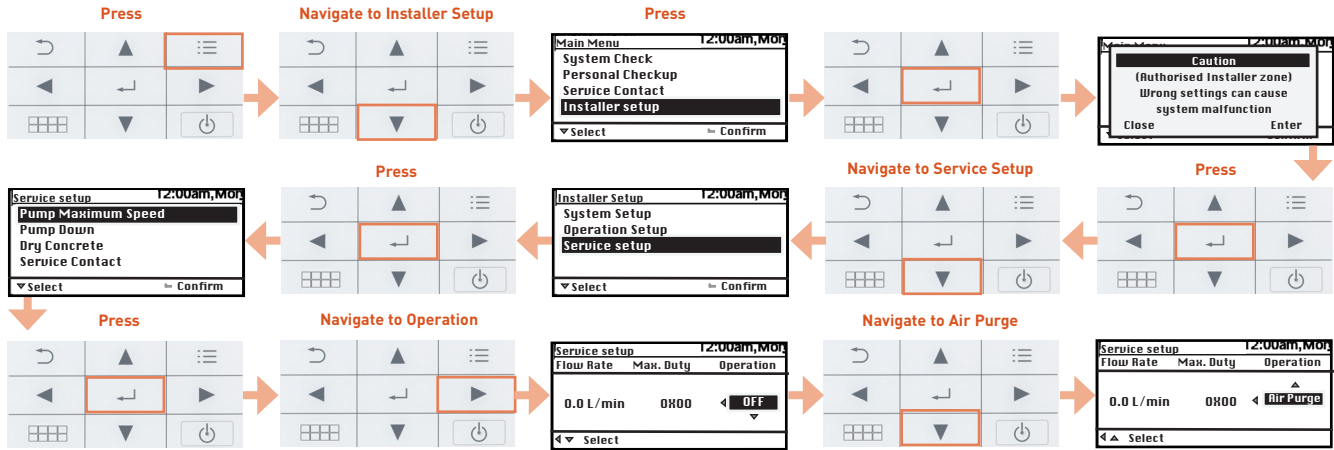

b) Set maximum pump speed: Use the flow rate display. The numbers are shown in hexadecimal and simply refer to the pump duty. Increase or decrease until the desired flow rate is shown, this will be the maximum pump speed.

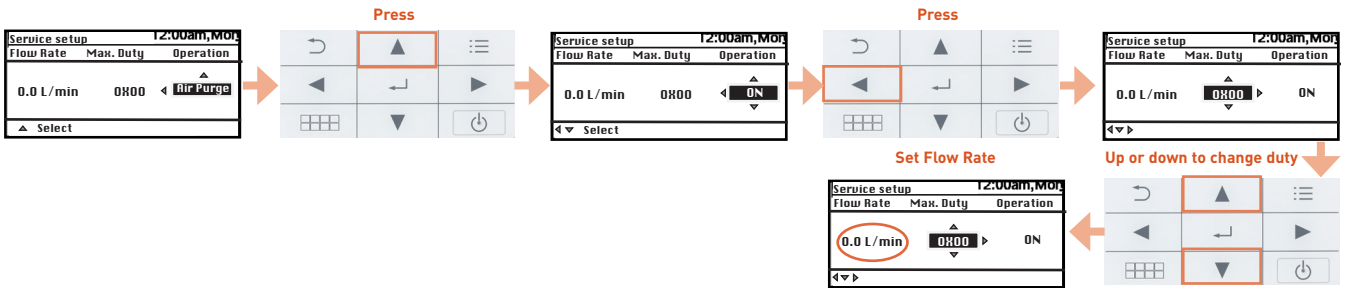

c) Return to Installer Setup Menu:

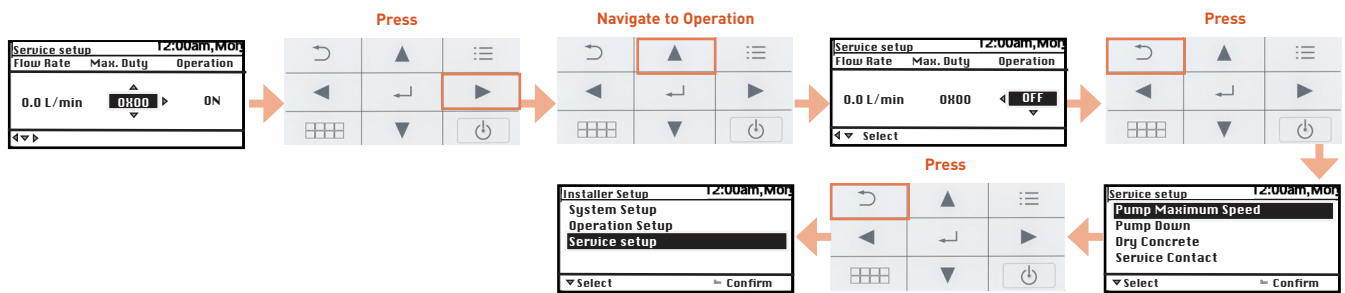

Step 3: System Setup

a) **Zone and Sensor setting:** This is how the heat pump will be controlled in heating mode. This can be controlled using:
 i. Water Temperature: Controlled using the heat pump flow temperature only. No room thermostat will be used.

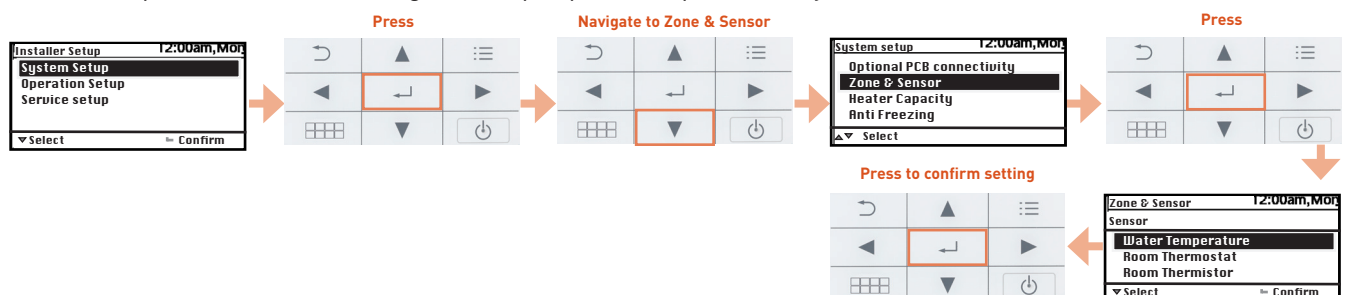

ii. Room Thermostat (External): Controlled using a 3rd party room thermostat using 230v switching.

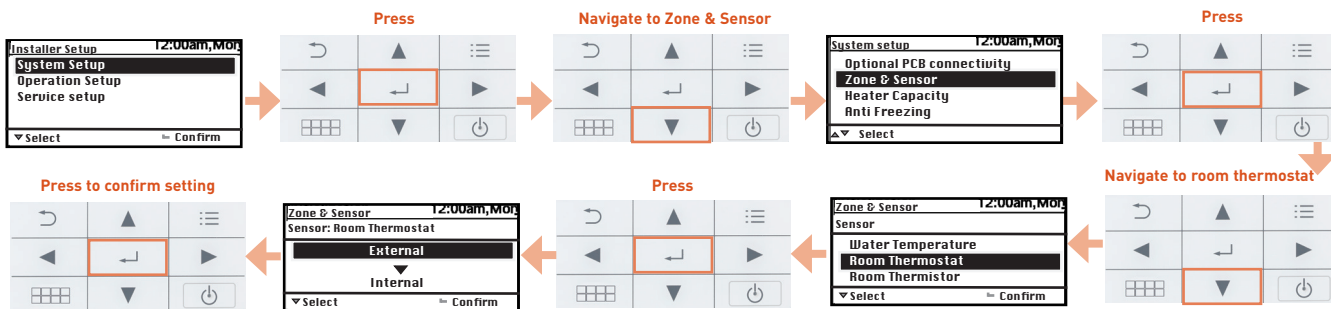

iii. Room Thermostat (Internal): Controlled using the heat pump remote controller as the room temperature sensor.

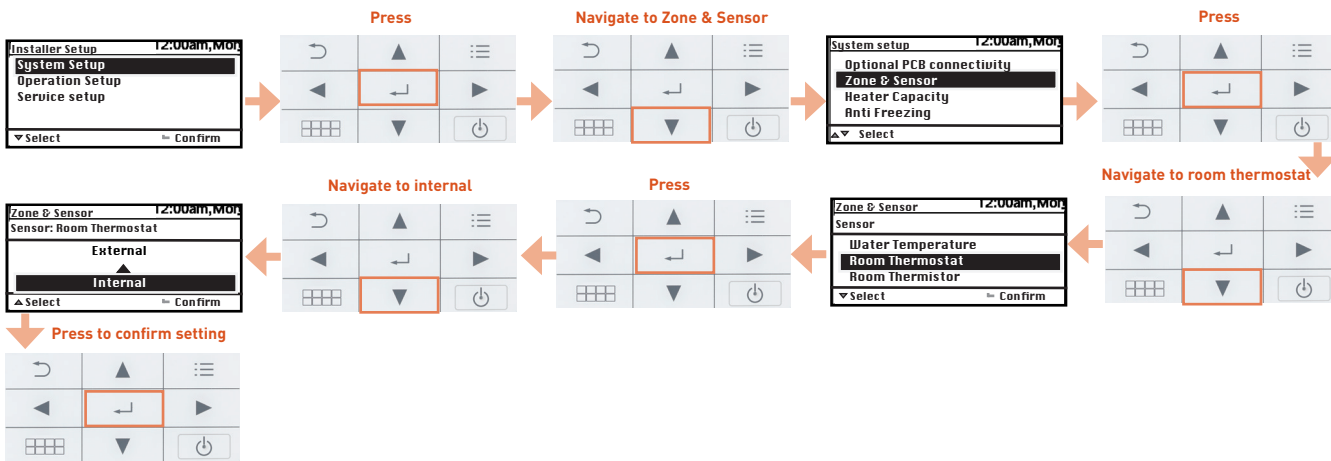

b) Heater Capacity Setting: This is to set the maximum capacity of the built in electrical element inside the monobloc heat pump. This is only applicable on heat pumps with 6kw or 9kw back-up heaters.

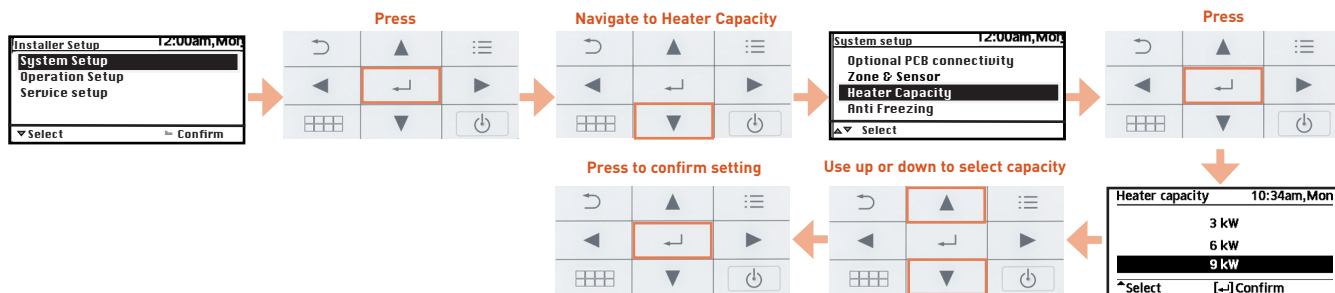

c) Tank Connection Setting: This is to tell the heat pump that it is going to be serving a DHW tank as well as heating. This must be set to "YES" when connecting a DHW tank to the system.

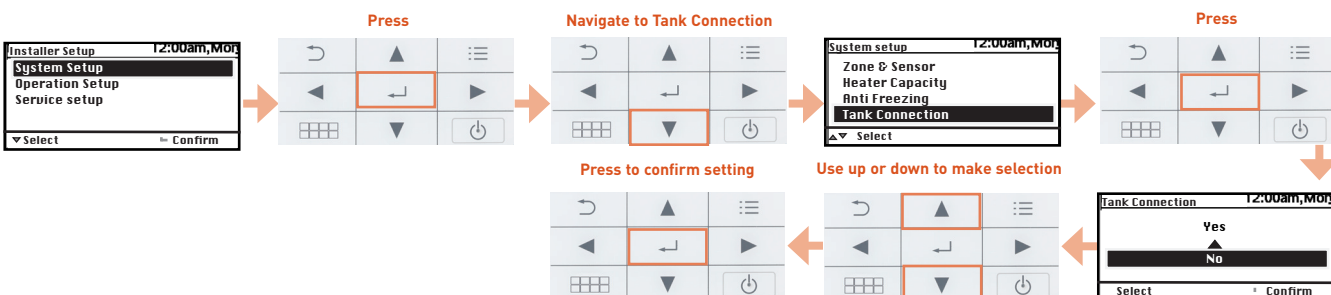

d) Tank Heater: This setting tells the system whether to use the built in “backup” electric heater (**internal** to the heat pump) or DHW tank “booster” (immersion) heater (**external** to the heat pump) for DHW electrical assistance.

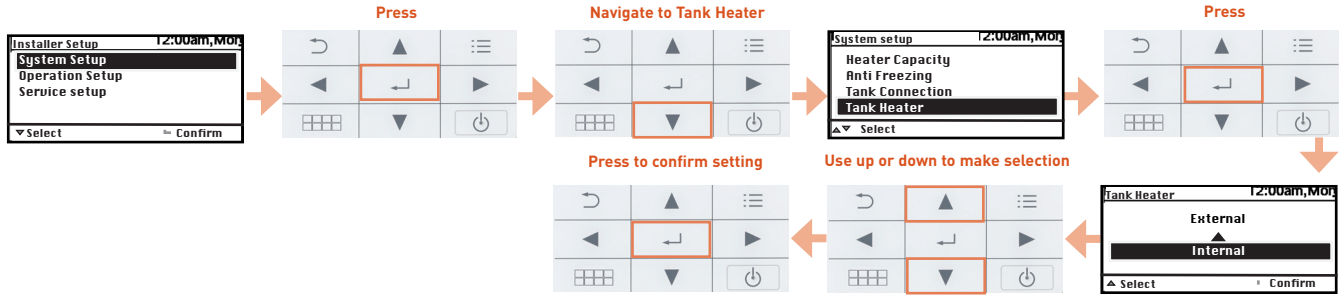

When set to “External, “Tank heater ON time” must be set. This is the delay time that the system will wait, after beginning a DHW cycle, before automatically engaging the booster heater.

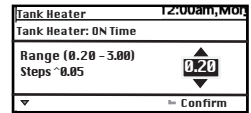

e) Circulation Liquid Setting: This is to indicate if the heat pump is filled with glycol or water.

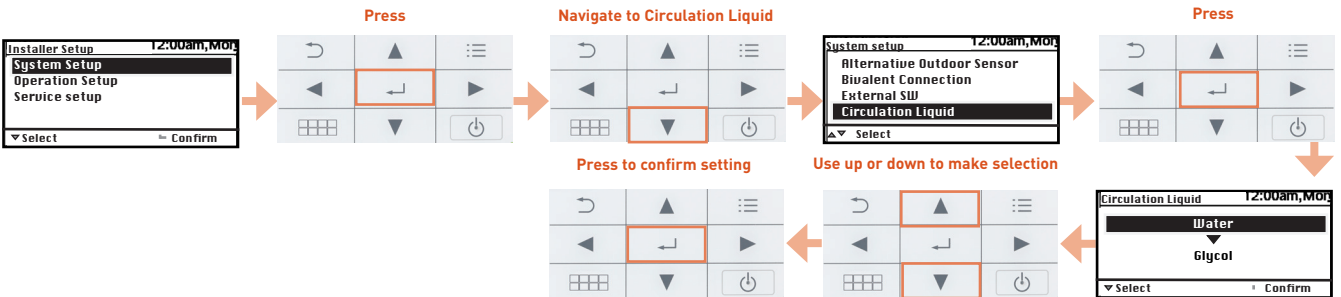

f) Force Heater Setting: This is to engage the electrical backup for heating & DHW, in the event of an error, manually or automatically.

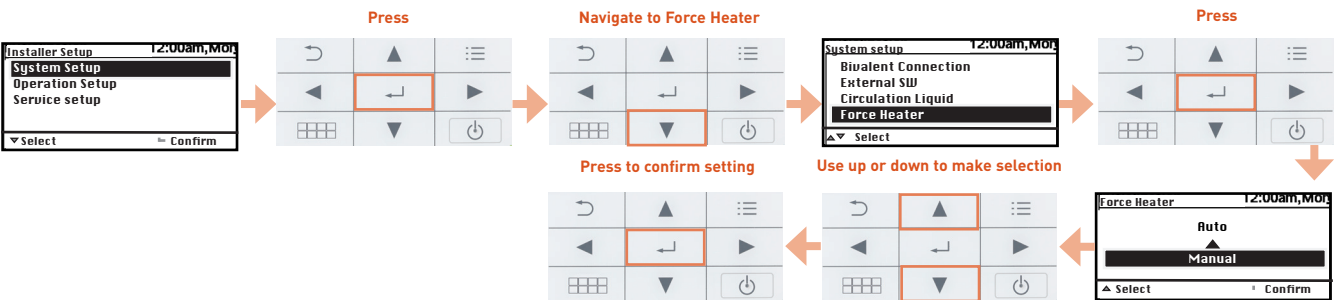

g) Return to Installer Menu

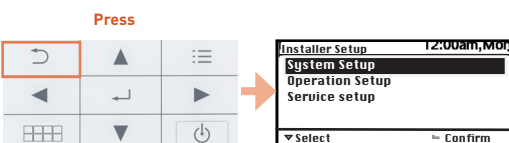

Step 4: Operation Setup

a) Heating Settings: This is where flow temperature settings are made.

i. Water temperature for heating on: Set if the heat pump will operate with a weather compensated flow temperature or a direct (fixed) flow temperature.

- **Compensation Curve:** These settings are entirely dependent on the heating system design. The heat pump will regulate it's flow temperature with respect to the outdoor temperature. The colder it is outside, the hotter the flow temperature will be.

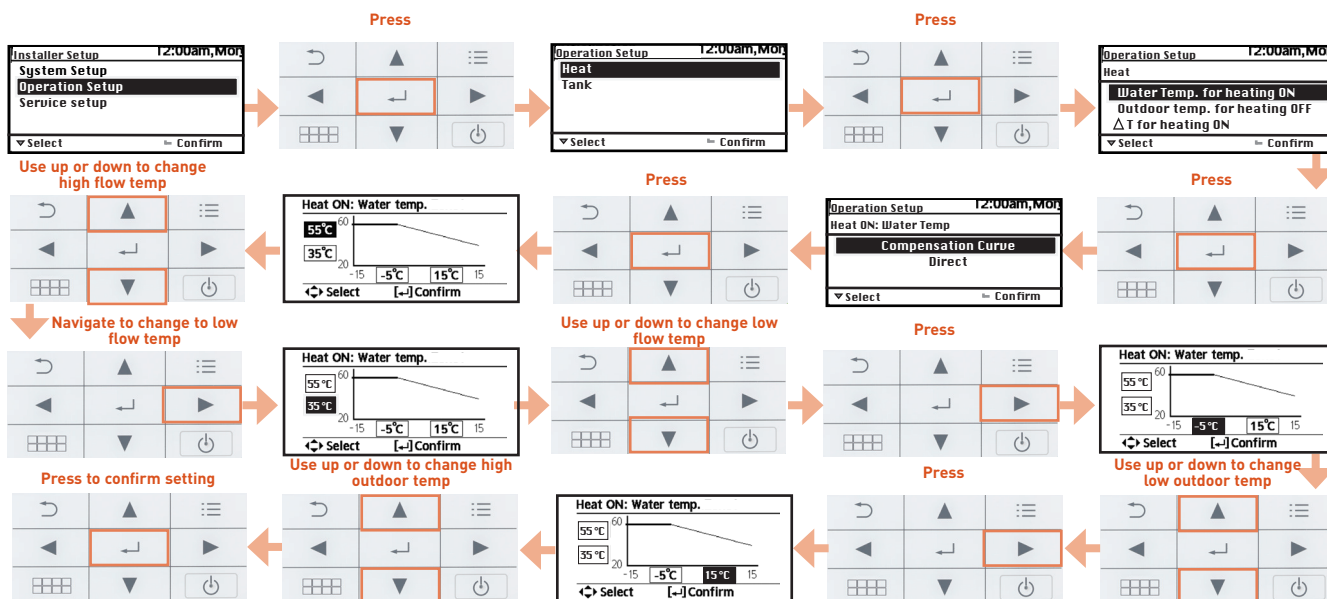
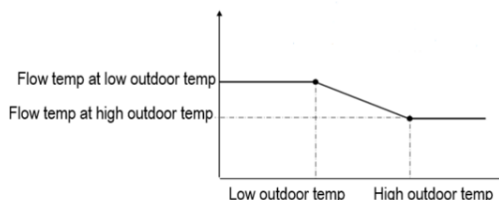

Suggested compensation curve settings (use as a guide only):

Under floor heating

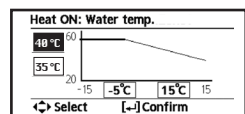

New build property (radiators)

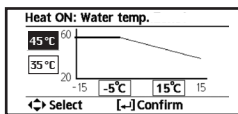

Old property (radiators)

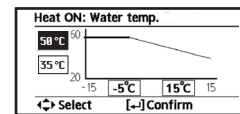

- **Direct Flow Temperature:** This will set a fixed flow temperature with no reference to outside temperature.

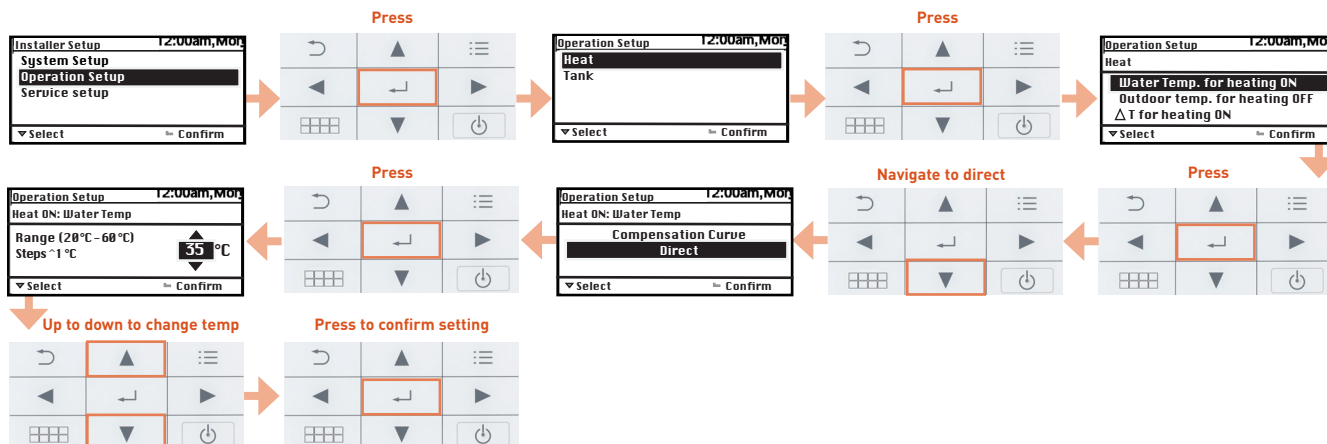

Suggested direct temperature settings (use as a guide only):

Under floor heating

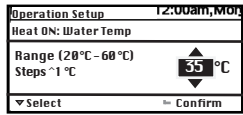

New build property (radiators)

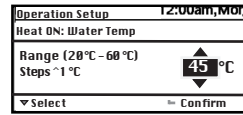

Old property (radiators)

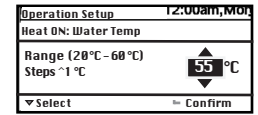

ii. Outdoor temperature for heater on: This is the outdoor temperature at which the electrical backup heater will be permitted to operate below, to assist the heat pump.

* T-CAP models can operate at full capacity at low outdoor temperatures.

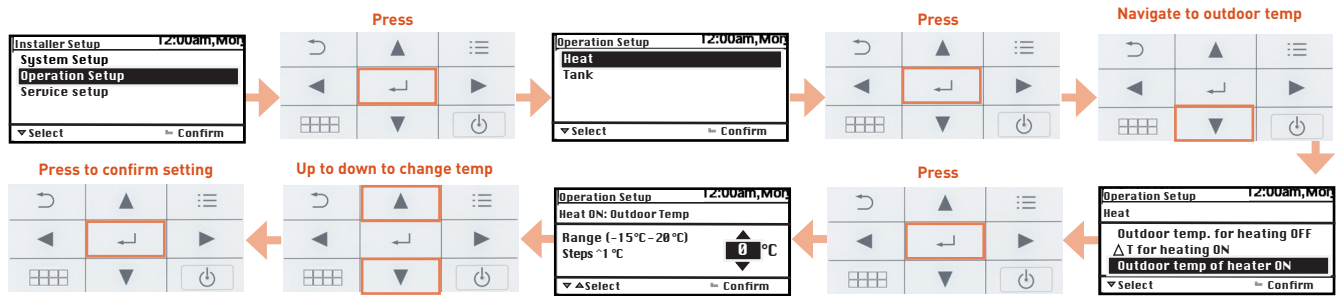

b) Tank Settings: This is where DHW and priority settings are made.

i. Floor operation time: This setting refers to heating priority and is rarely implemented in most systems; however, it should be set to avoid lack of DHW.

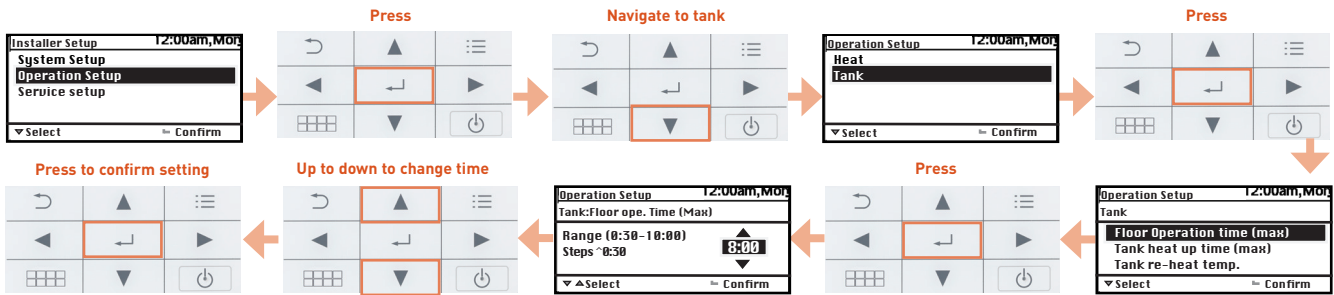

Suggested floor operation time settings (use as a guide only):

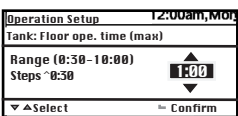

ii. Tank heat up time (max): DHW priority setting.

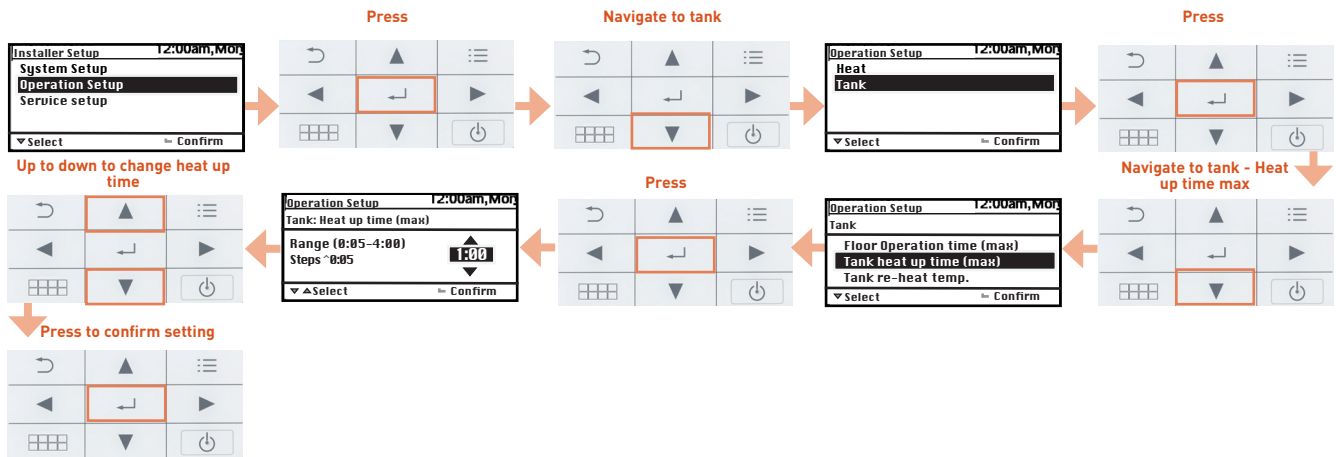

Suggested tank heat up time (max) settings (use as a guide only):

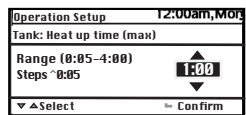

iii. Tank re-heat temp: This is the temperature drop in the DHW tank before the heat pump will begin to re-heat DHW.

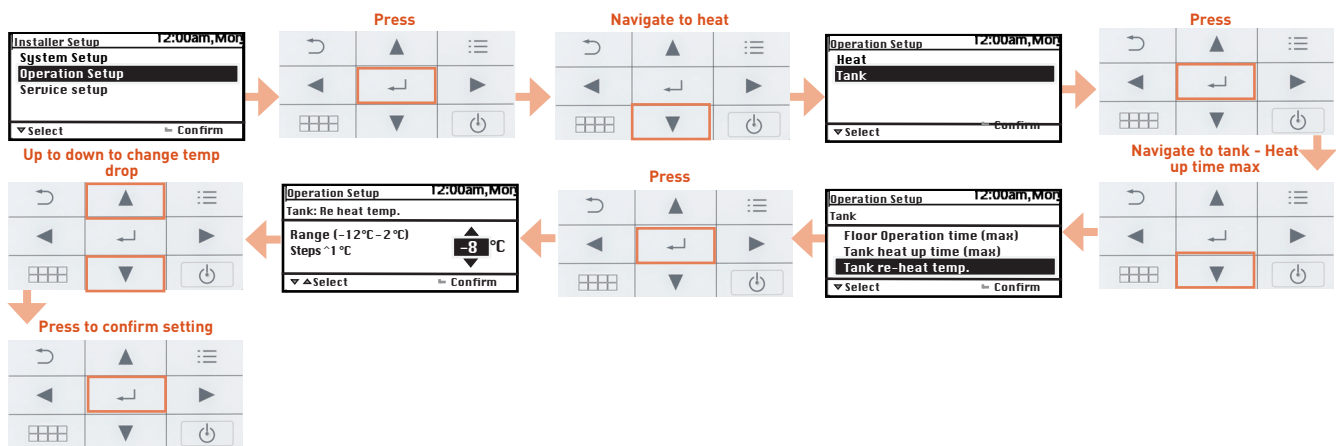

Suggested tank heat up time (max) settings (use as a guide only):

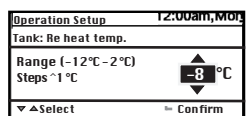

iv. **Sterilization:** This is an anti-legionella function used to raise the temperature of the DHW periodically.

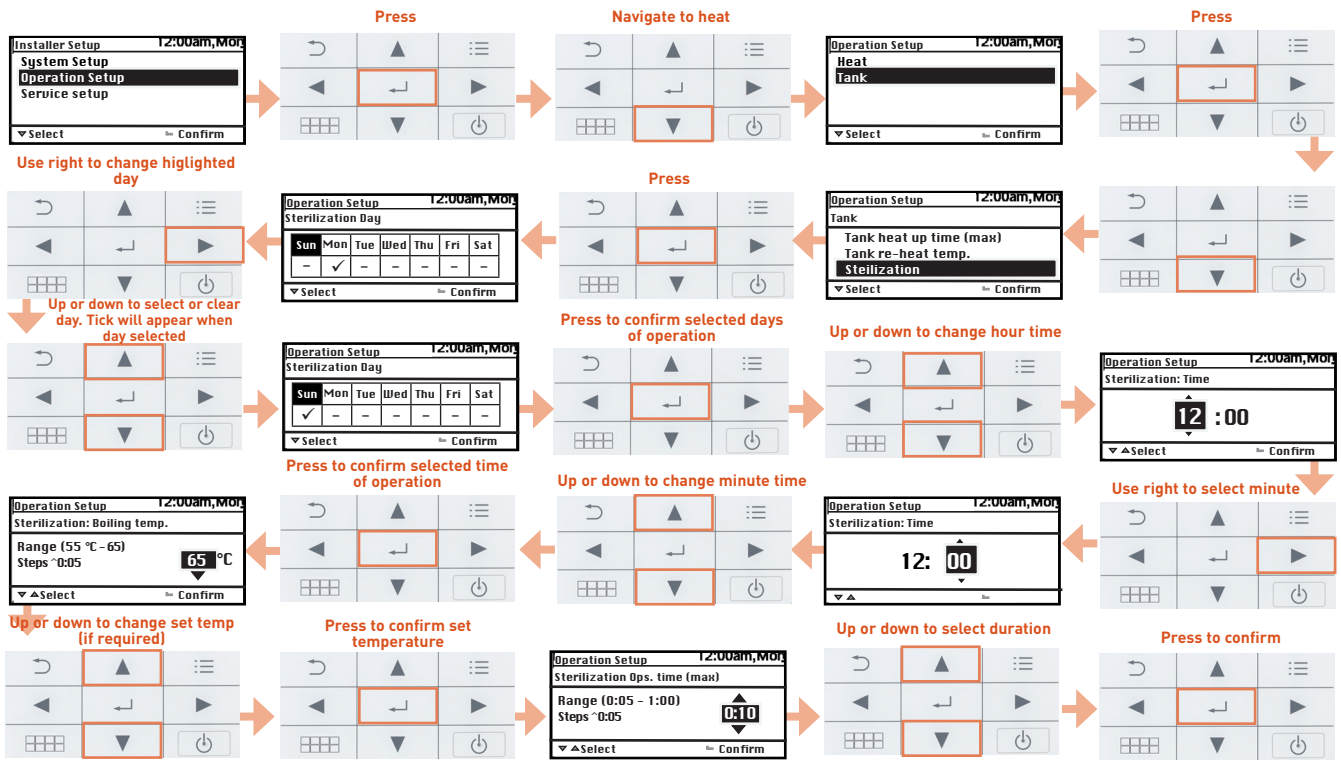

c) **Return to Main Menu:**

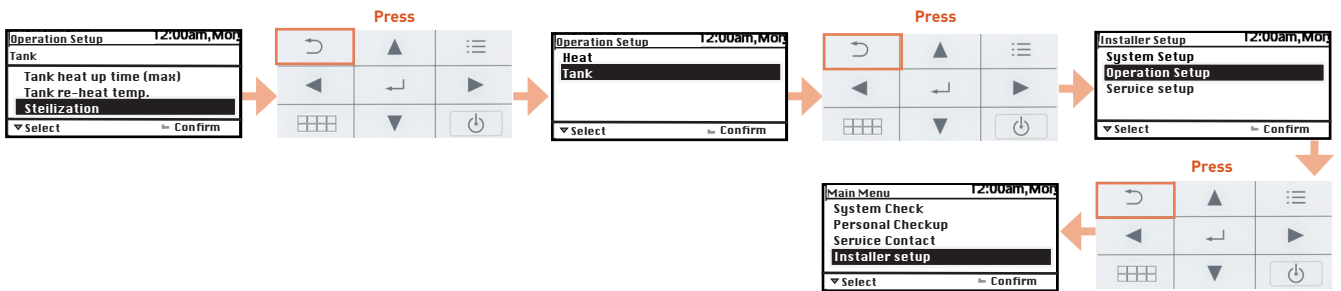

Step 5: Function Setup

a) Room Heater: This setting enables the backup heater to activated in heating mode, if required. If set to “No”, it will never activate (except for anti-freeze or defrost function).

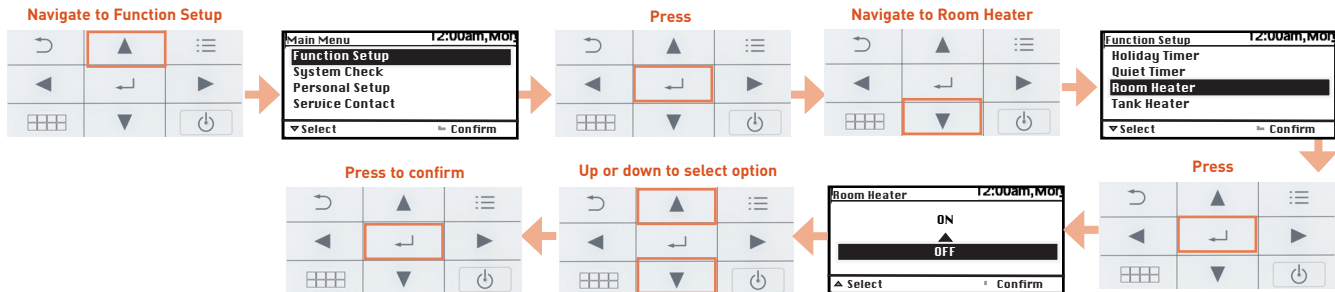

b) Tank Heater: This setting enables the backup heater or booster heater (which ever it is set to in system setup) to activate in DHW mode. If set to “No”, it will never activate.

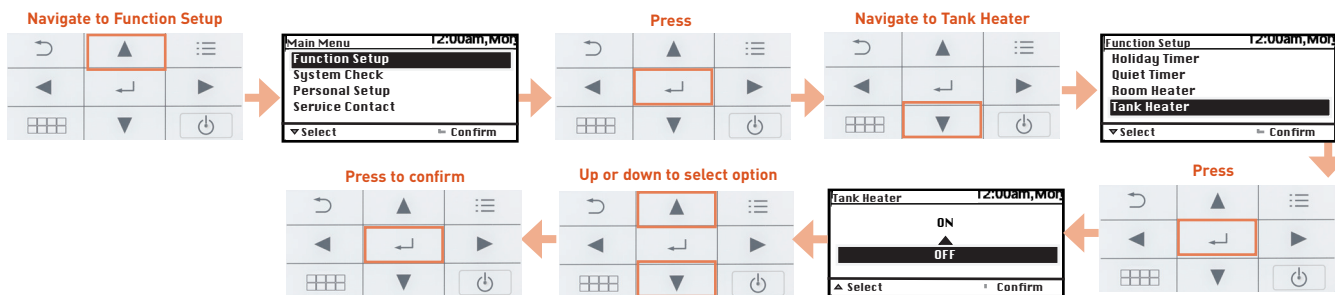

c) Sterilization: This setting enables the DHW sterilization function. If set to “No”, it will never activate.

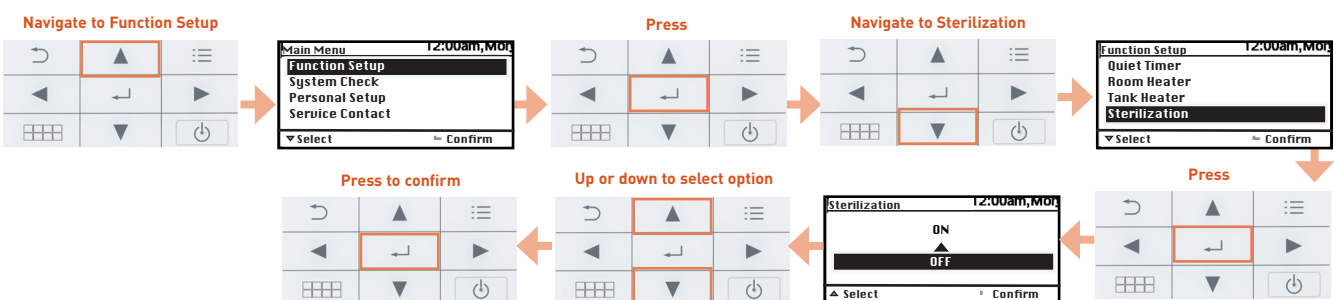

d) Return to Main Screen:

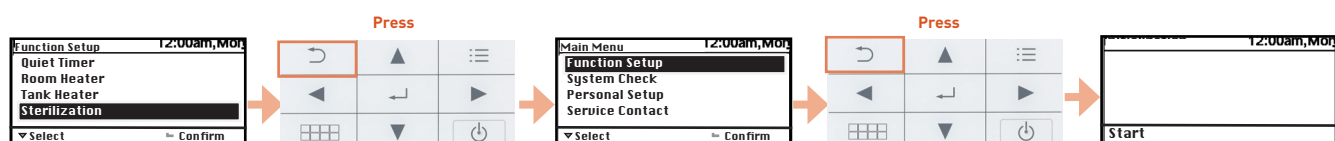

Step 6: Operating the system

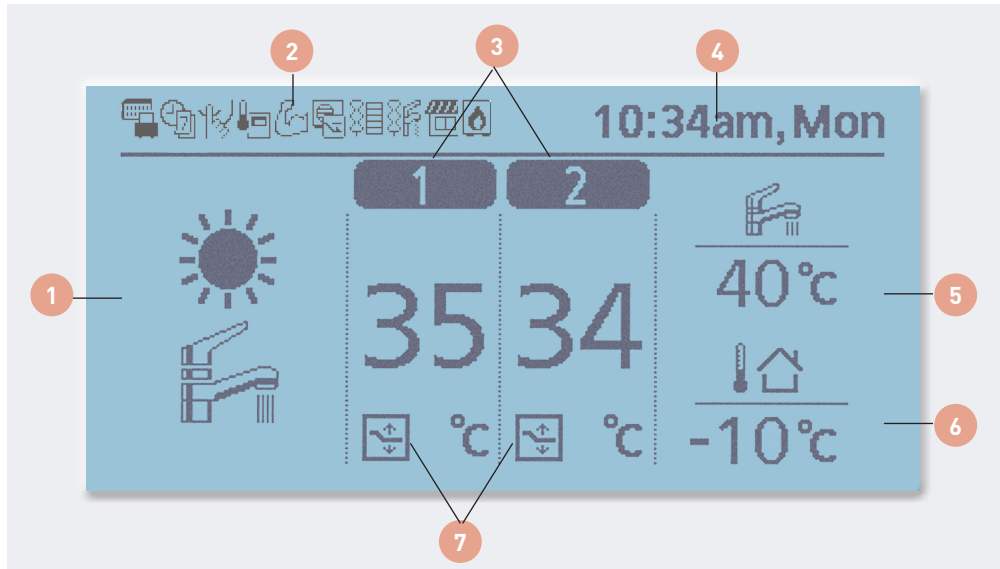



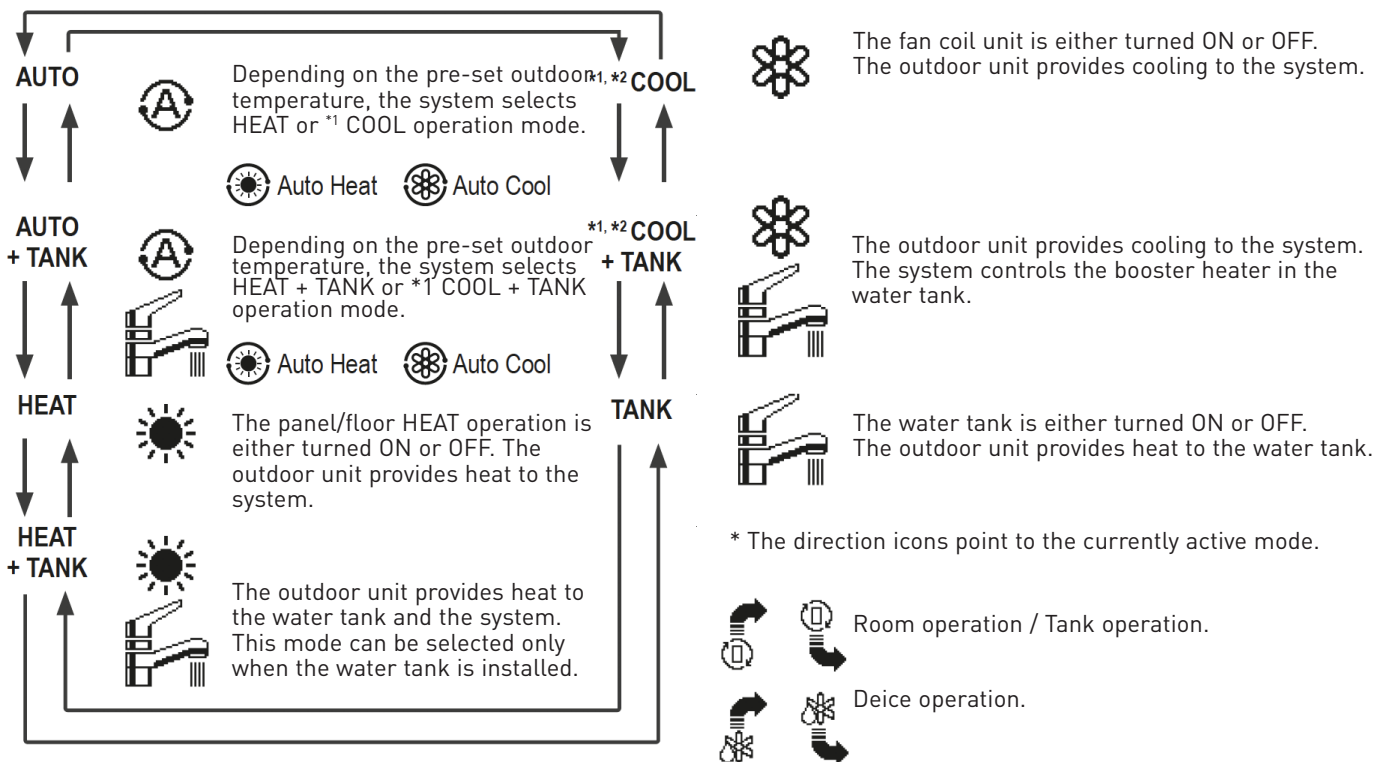







1 Mode selection



*1 The system is locked to operate without COOL mode. It can be unlocked only by authorised installers or our authorised service partners.
 *2 Only displayed when COOL mode is unlocked (This means when COOL mode is available).

2 Operations icons

The status of operation is displayed. These icons will not display (under operation OFF screen) whenever the operation is OFF except weekly timer.

 Holiday operation status	 Weekly Timer operation status	 Solar status
 Quiet operation status	 Powerful operation status	 Bivalent status (Boiler)
 Zone: Room Thermostat → Internal sensor status	 Tank Heater status	
 Room Heater status	 Demand Control or SG ready or SHP status	







3 Temperature of each zone

4 Time and Day

5 Water tank temperature

6 Outdoor temperature

7 Sensor type/Set temperature type icons

 Water Temperature --> Compensation curve	 Water Temperature --> Direct	 Pool only
 Room Thermostat --> External	 Room Thermostat --> Internal	 Room Thermistor

Switching the Heat Pump On



The green LED in the bottom right hand corner will light up and the display will show

(Display may differ depending on system settings)



Changing the mode

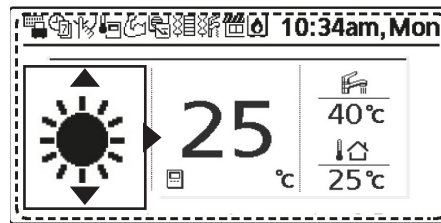
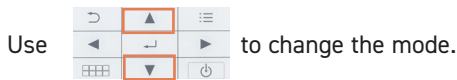
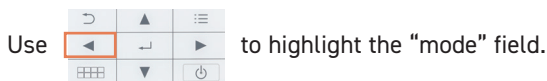

Heating only

DHW Only

Heating & DHW

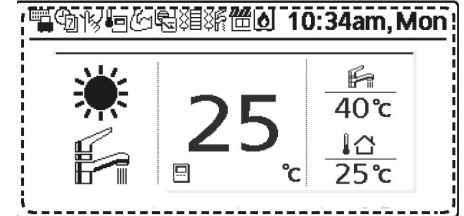
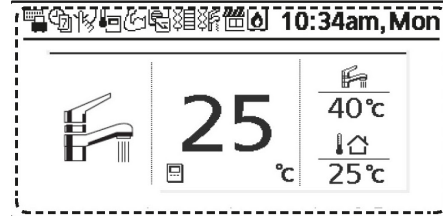
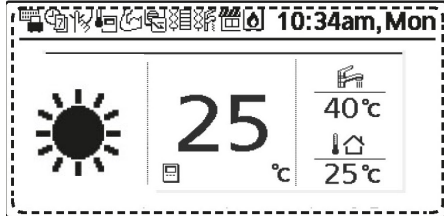

Changing the Heating Temperature:

This depends on the zone & sensor / water temp for heating on settings. Follow the below procedure for the setup you have:

1) Water Temperature - Direct

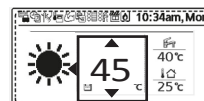
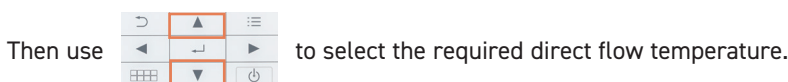
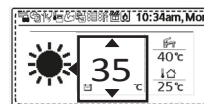
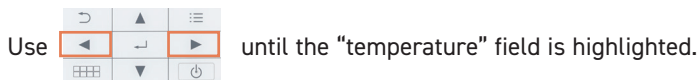

The heat pump will operate to achieve and maintain this flow temperature during heating mode only.

(The value in the "temperature" field, when it is not highlighted, is the actual flow temperature.)

2) Water Temperature - Weather Compensation

Use  until the "temperature" field is highlighted.

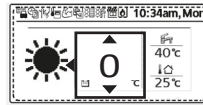

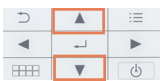
Then use  to select the compensation curve shift (offset) value.

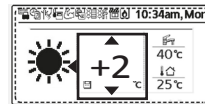

This allows the heat curve to be fine-tuned. The relationship between flow and outdoor temperature remains constant but the overall temperatures are increased or decreased together.

(The value in the "temperature" field, when it is not highlighted, is the actual flow temperature.)

3) Room Thermostat (External) - Direct

The room temperature setpoint can only be changed on the room thermostat itself. This will tell the heat pump to run or stop in heating mode. The heat pump will simply work to the direct flow temperature that was set in the operation setup.

If the "temperature" field is highlighted, room thermostat (external) icon will show but no changes can be made.

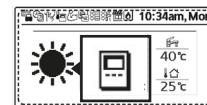

(The value in the "temperature" field, when it is not highlighted, is the actual flow temperature.)

4) Room Thermostat (External) - Weather Compensation

The room temperature setpoint can only be changed on the room thermostat itself. This will tell the heat pump to run or stop in heating mode. The heat pump will simply work to a weather compensated flow temperature according to the heat curve that was set in the operation setup.

If the "temperature" field is highlighted, room thermostat (external) icon will show but no changes can be made.

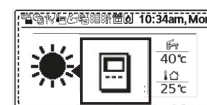

(The value in the "temperature" field, when it is not highlighted, is the actual flow temperature.)

5) Room Thermostat (Internal) - Direct

Use  until the "temperature" field is highlighted.

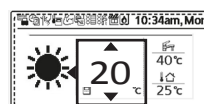

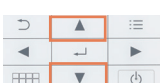
Then use  to select the desired room temperature setpoint.





The heat pump will operate to achieve and maintain this room temperature using the direct flow temperature.

(The value in the "temperature" field, when it is not highlighted, is the actual room temperature.)

6) Room Thermostat (Internal) - Weather Compensation

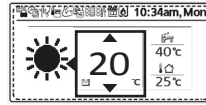
Use  until the "temperature" field is highlighted.



Then use  to select the desired room temperature setpoint.

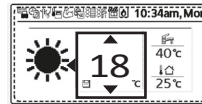

The heat pump will operate to achieve and maintain this room temperature using the weather compensated flow temperature.

(The value in the "temperature" field, when it is not highlighted, is the actual room temperature.)

7) Changing the DHW Temperature

The DHW setpoint can only be changed when the heat pump is in DHW or DHW & Heating mode.

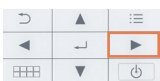
Use  to highlight "tank setpoint" field.



Then use  to select the desired DHW temperature.

(The value in the "DHW setpoint" field, when it is not highlighted, is the actual DHW temperature.)

Step 7: System Checks

While the heat pump is operating, system checks can be made with reference to sensor readings and other operating information.

a) Energy Monitor*: Shows current and historical performance data.

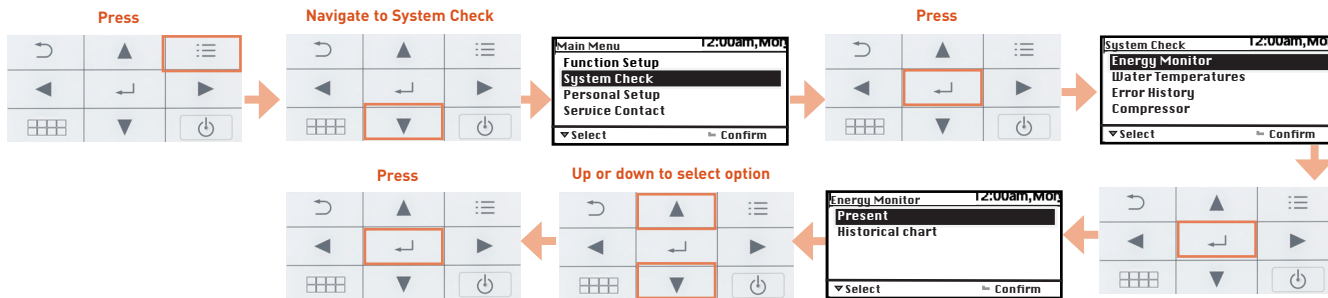

b) Water Temperatures: Shows current outlet/inlet etc temperatures.

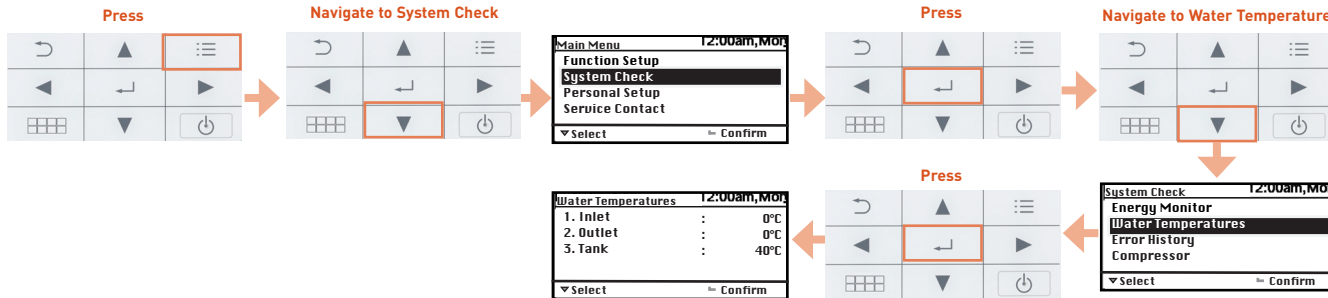

c) Error History: Shows any stored system errors.

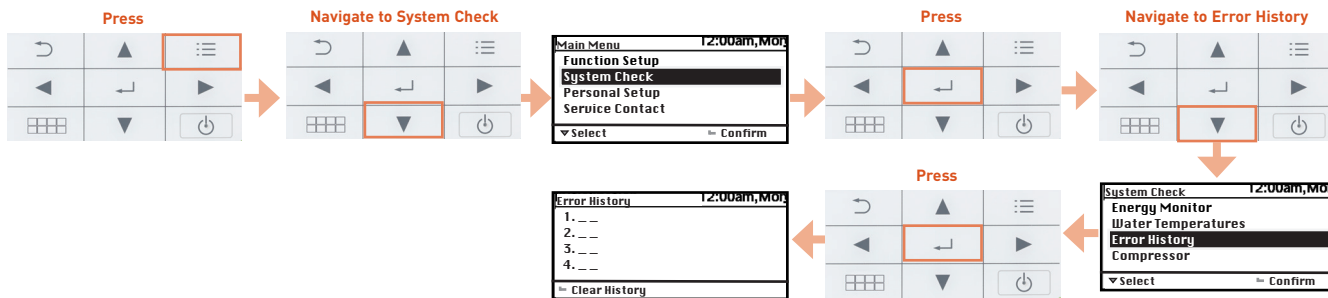

d) Compressor: Shows information about the compressor.

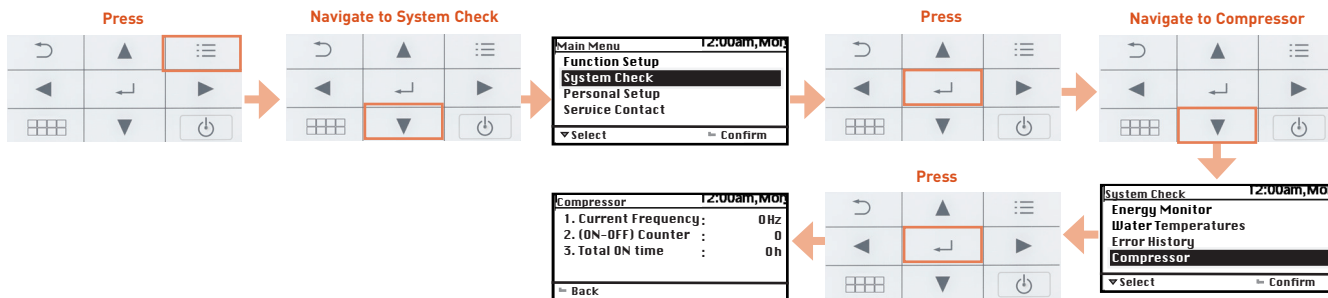

*Energy Monitor is for indication purposes only, this is not a calibrated monitor.

e) **Heater:** Shows information about the electrical backup/booster heaters for heating and DHW.

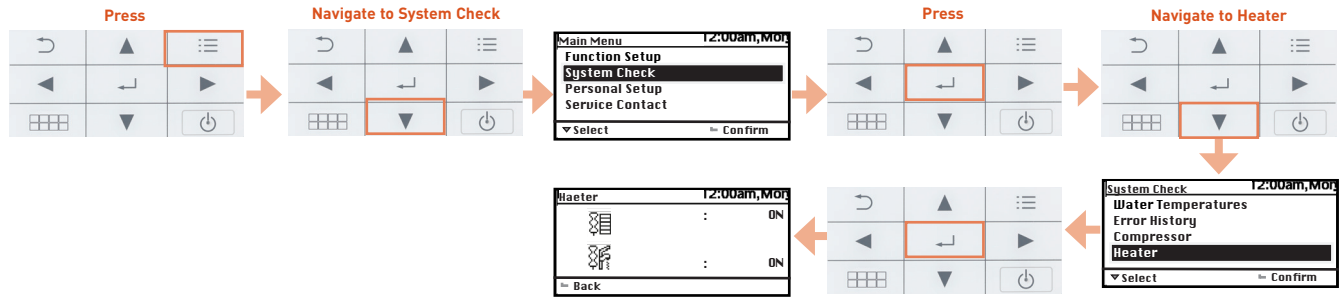

f) **Flowrate Check:** Check the actual flowrate of the system while it's running.



SCAN TO VIEW OUR YOUTUBE
INSTALLATION PLAYLIST



Error Codes during commissioning

To check the error code:

- When the abnormality occurs the system will stop and OFF/ON control panel LED will blink.
- The error code of the abnormality will be display on the control panel.

H36: Abnormal Buffer Tank Sensor

This is due to "Buffer Tank Connection" setting "Yes" and the system can't see the buffer sensor.

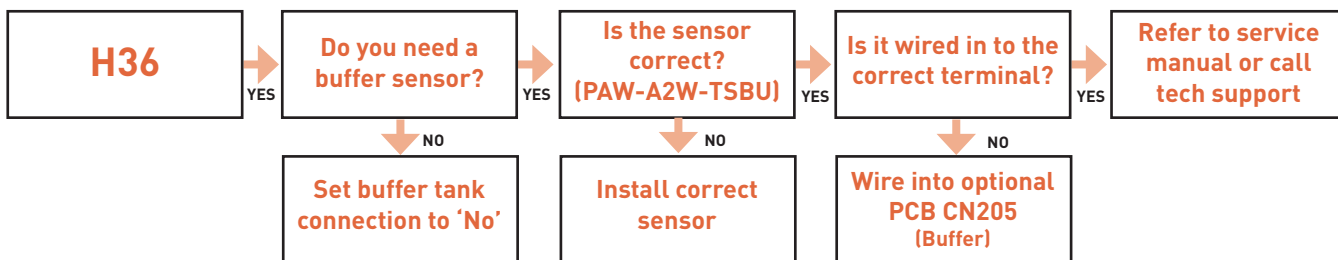

H43: Abnormal water temperature sensor Zone 1

When the Optional PCB (CZ-NS4P) is used, the system requires a zone water temperature sensor. This error means the system can't see the sensor.

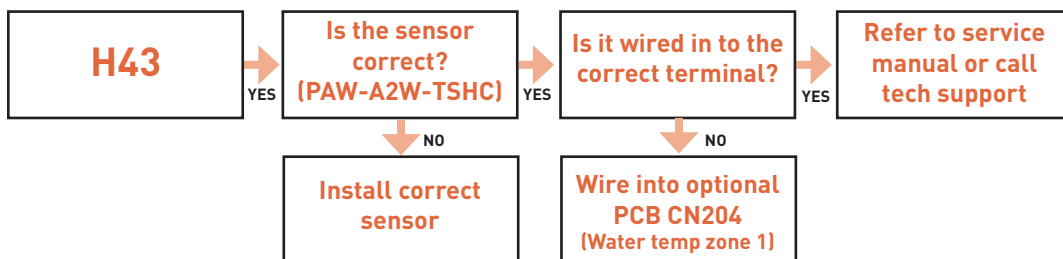

H44: Abnormal water temperature sensor Zone 2

When the Optional PCB (CZ-NS4P) is used and using 2 zone configuration, the system requires a zone water temperature sensor. This error means the system can't see the sensor.

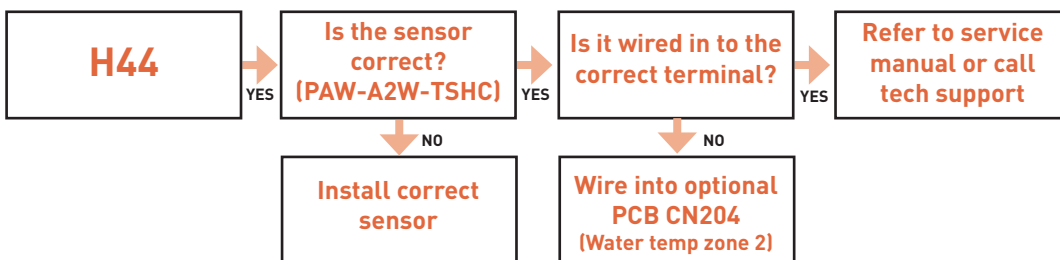

H62: Primary Flow Error

This error occurs when the flow sensor detects a problem with the primary flow rate. This is usually because the flow rate is too low.

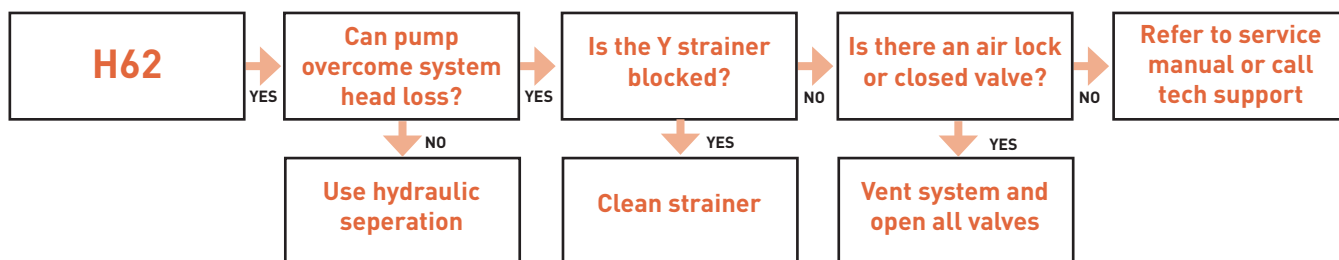

Error Codes during commissioning

H67: Abnormal Room Thermistor Zone 1

This is due to "Zone & Sensor" setting Zone 1 set to "Room Thermistor", but the system can't see the thermistor.

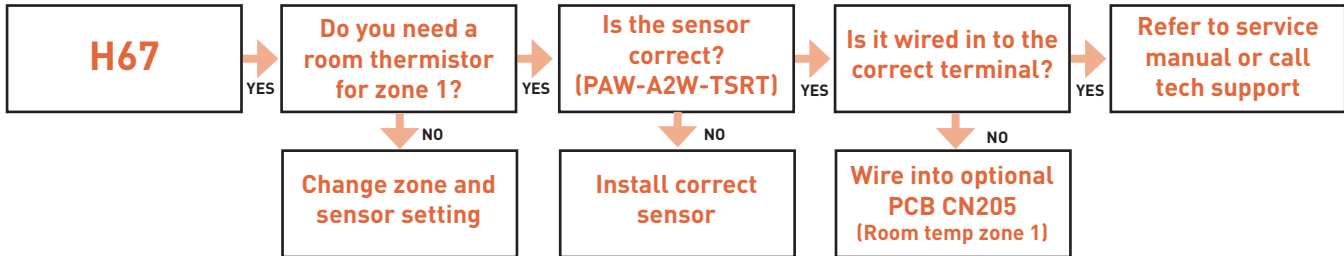

H68: Abnormal Room Thermistor Zone 2

This is due to "Zone & Sensor" setting Zone 2 set to "Room Thermistor", but the system can't see the thermistor.

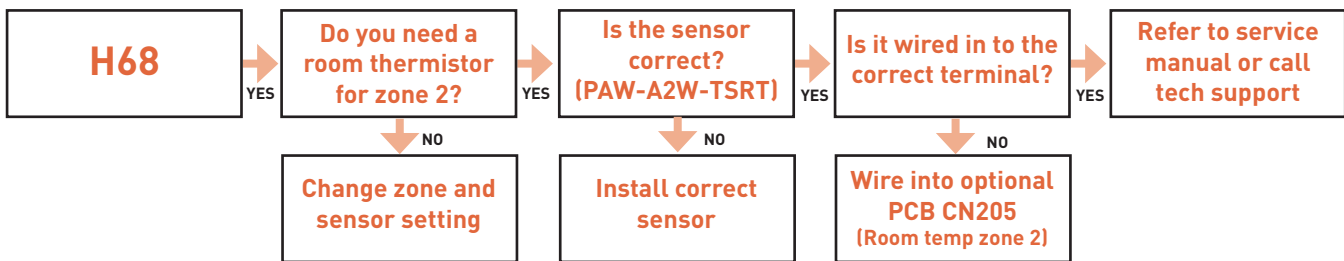

H70: Backup Heater OLP (over load protection)

The internal electrical backup heater has built in over heat thermostats. If one of these trip and become open circuit, H70 occurs. The system will also show H70 when the backup heater power supply is missing. This error will only occur at the time when the backup heater is activated.

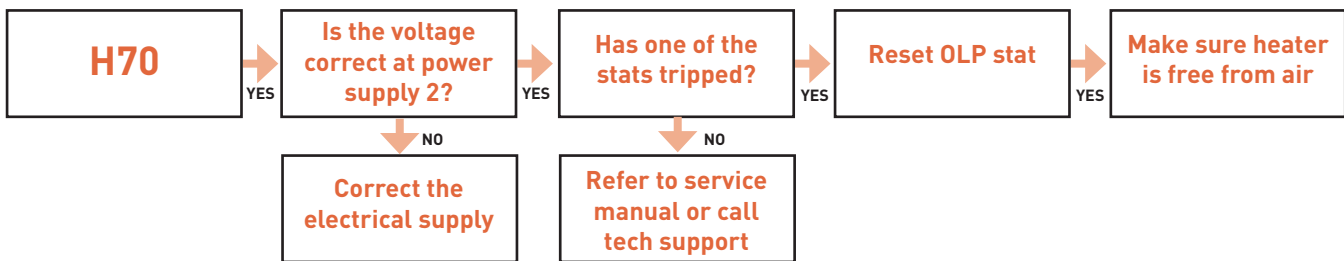

H72: Abnormal DHW Tank Sensor

This is due to "Tank Connection" set to "Yes" but the system can't see the tank sensor.

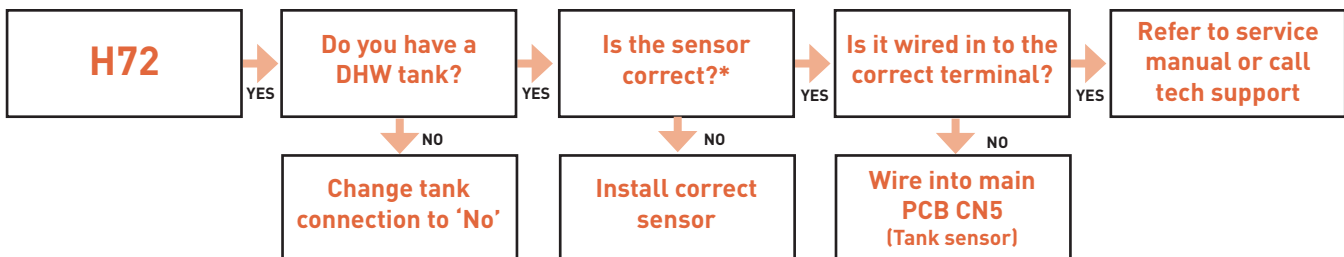

* Optional Panasonic tank sensor

PAW-TS1 (Tank sensor with 6 m cable length)

PAW-TS2 (Tank sensor with 20 m cable length)

PAW-TS4 (Tank sensor with 6 m cable length and only 6 mm diameter)

CZ-TK1 (Tank sensor kit for third party tank with copper pocket and 20m length sensor cable)

H91: Tank Heater OLP (over load protection)

When "Tank Heater" set to "External" the system will error if the tank heater OLP is open circuit. This is like a high limit for the booster (immersion) heater. This error will only occur when the booster heater is actually activated.

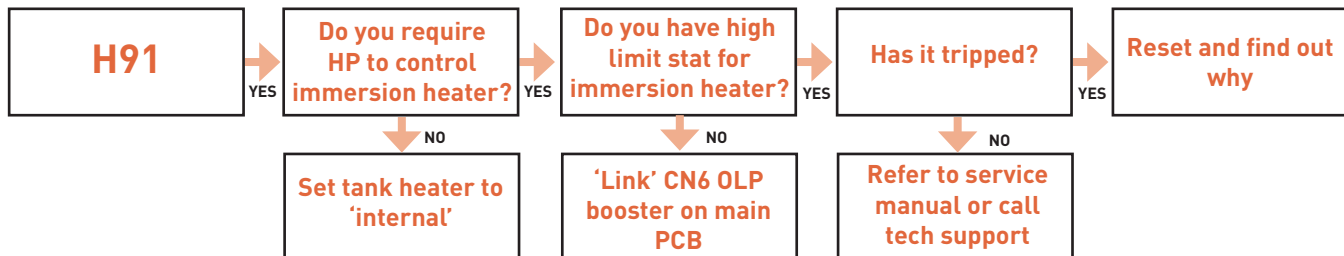

Panasonic Technical Support contact details

Telephone: 01344 85 3393

Email: uk-aircon-tech@eu.panasonic.com

Advanced Installations

2 zone setup - Heating circuit

The basic principle is that both heating circuits will draw off the buffer tank independently, using their own circulating pump. The flow temperature of each zone is monitored by the heat pump using zone water temperature sensors, which are mandatory to the installation. These sensors are placed on the flow pipe for both circuits. Both zones can be set to differing flow temperatures but can only be physically regulated differently when mixing valves are used. (e.g. If zone 1 is a radiator circuit set to operate at 50°C and zone 2 is an UFH circuit set to operate at 35°C, the heat pump would operate to 50°C and control zone 2 mixing valve to blend 50°C down to 35°C. Of course, the mixing valve is not necessary if the UFH manifold already has a thermostatic blending valve built in; therefore, the flow temperature setting could be the same for both circuits.) The heat pump will always operate to the higher of the two flow temperature settings in heating mode and the cooler of the two flow temperature settings in cooling mode.

Both zones can be controlled using either:

- **Water Temperature** (flow temperature for each zone, no room temperatures are used)
- **Room Thermostat** Internal (remote controller sensor as room temperature reference)
- **Room Thermostat** External (3rd party thermostat as room temperature reference)
- **Room Thermistor** (Panasonic room sensor as room temperature reference (both zones can be controlled by differing methods)).

Accessories that are MANDATORY for 2 zone installations:

- Optional PCB (CZ-NS4P)
- 2x Zone Water Sensors (PAW-A2W-TSHC)
- Circulating Pumps (Field Supplied)

Accessories that are optional (depending on your installation) for 2 zone installations:

- Panasonic Room Thermistor (PAW-A2W-TSRT)
- Buffer Tank Sensor (PAW-A2W-TSBU)
- Panasonic Room Thermostat 230v switching (PAW-A2W-RTWIRED)
- Panasonic Wireless Room Thermostat 230v switching (PAW-A2W-RTWIRELESS)
- 3rd Party Room Thermostat 230v switching (Field Supplied)
- Blending Valves (Field Supplied)

Installation Schematic

2 Zone - Direct Flow Temperatures:

Both circuits can be set to different flow temperatures but the heat pump will always work to the higher of the two (heating mode) and lower of the two (cooling mode).

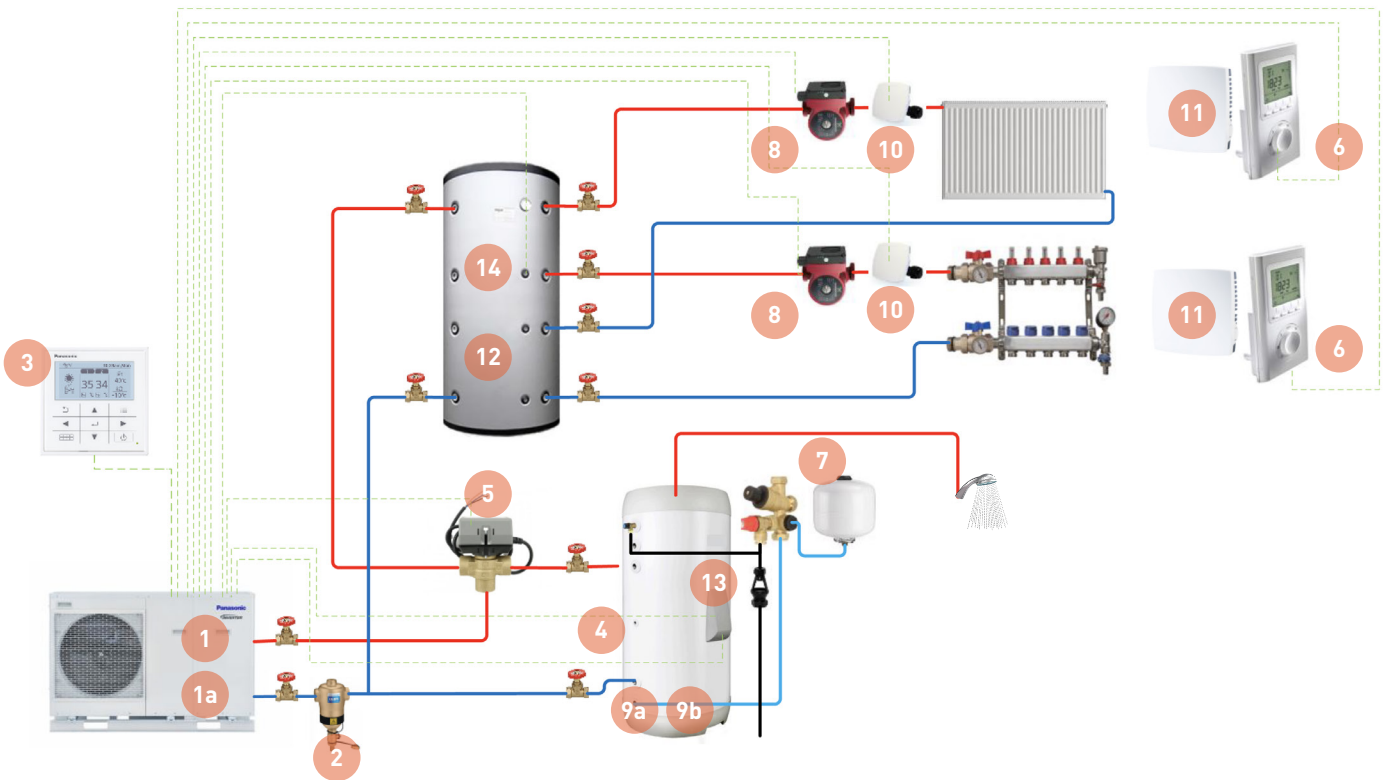

Number	Description	Type of Recommendation	Panasonic Part Number
1	Monobloc Unit	Mandatory	---
1a	PCB for advanced functions	Mandatory	CZ-NS4P
2	Magnetic Particle Filter	Mandatory on "H" Series Recommended on "J" Series*	---
3	Remote Controller	Supplied with Monobloc Unit	---
4	Tank Sensor	Supplied with a Panasonic DHW tank, if 3rd party tank used then has to be purchased separately (20m)	PAW-TS2
5	3 Way Valve	Mandatory if DHW tank installed	PAW-3WYVLV-HW
6	Room Thermostat (external)	Recommended (can be field supplied)	PAW-A2W-RTWIRED
7	G3 Kit	Mandatory (supplied with tank)	PAW-G3KIT
8	Circulating Pump	Mandatory (field supplied)	---
9a	200/70L DHW/Buffer Cylinder	Mandatory if DHW is required	PAW-TD20B7PP-UK
9b	300/70L DHW Buffer Cylinder	Mandatory if DHW is required	PAW-TD30B7PP-UK
10	Zone Water Sensor	Mandatory	PAW-AW-TSHC
11	Zone Room Thermistor	Mandatory	PAW-AW-TSRT
12	Buffer Tank	Mandatory (field supplied)	---
13	Immersion (Booster) Heater	Mandatory	---
14	Buffer Sensor	Mandatory	PAW-AW-TSBU

*"J" series has a small inbuilt magnetic particle filter.

Installation Schematic

2 Zone Layout - Direct & Mixed:

One zone is direct and the other can be mixed to blend the flow temperature down (heating mode). No settings need to be made to incorporate the mixing valve, simply wire it in.

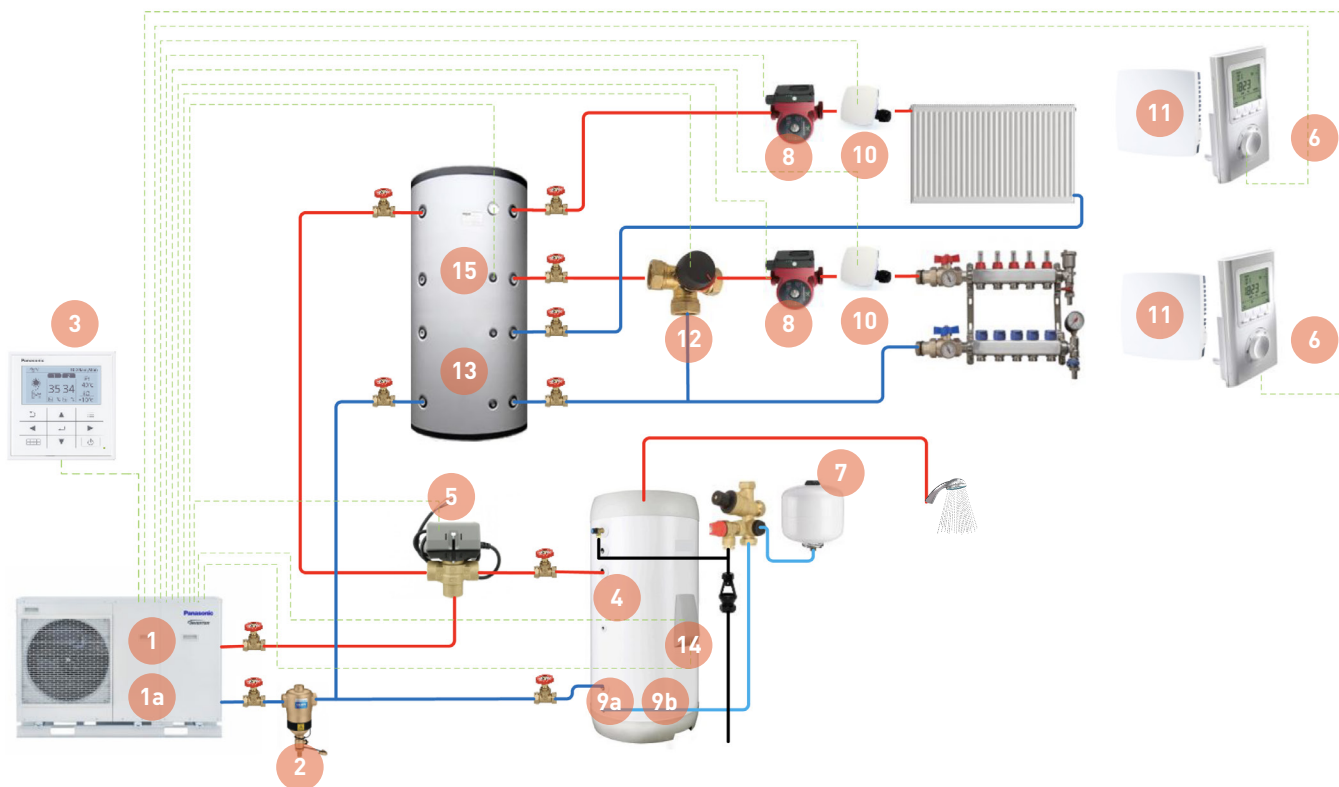

Number	Description	Type of Recommendation	Panasonic Part Number
1	Monobloc Unit	Mandatory	---
1a	PCB for advanced functions	Mandatory	CZ-NS4P
2	Magnetic Particle Filter	Mandatory on "H" Series Recommended on "J" Series*	---
3	Remote Controller	Supplied with Monobloc Unit	---
4	Tank Sensor	Supplied with a Panasonic DHW tank, if 3rd party tank used then has to be purchased separately (20m)	PAW-TS2
5	3 Way Valve	Mandatory if DHW tank installed	PAW-3WYVLV-HW
6	Room Thermostat (external)	Recommended (can be field supplied)	PAW-A2W-RTWIRED
7	G3 Kit	Mandatory (supplied with tank)	PAW-G3KIT
8	Circulating Pump	Mandatory (field supplied)	---
9a	200/70L DHW/Buffer Cylinder	Mandatory if DHW is required	PAW-TD20B7PP-UK
9b	300/70L DHW Buffer Cylinder	Mandatory if DHW is required	PAW-TD30B7PP-UK
10	Zone Water Sensor	Mandatory	PAW-AW-TSHC
11	Zone Room Thermistor	Mandatory	PAW-AW-TSRT
12	Mixer Valve	Mandatory (field supplied)	---
13	Buffer Tank	Mandatory (field supplied)	---
14	Immersion (Booster) Heater	Mandatory	---
15	Buffer Sensor	Mandatory	PAW-AW-TSBU

*"J" series has a small inbuilt magnetic particle filter.

Installation Schematic

2 Zone Layout - Both Mixed:

Both circuits can regulate their flow temperature independently. The heat pump will always work to the higher of the two (heating mode) and lower of the two (cooling mode). No settings need to be made to incorporate the mixing valves, simply wire them in.

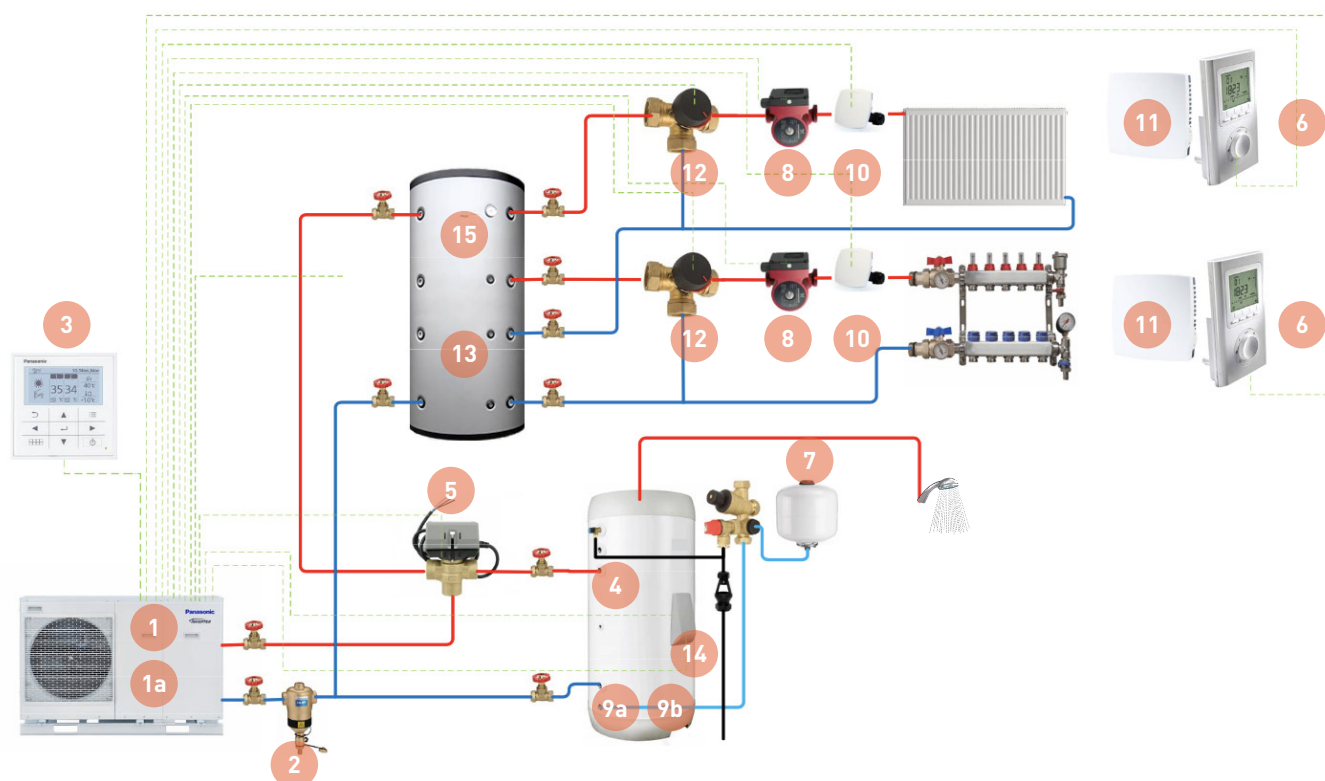

Number	Description	Type of Recommendation	Panasonic Part Number
1	Monobloc Unit	Mandatory	---
1a	PCB for advanced functions	Mandatory	CZ-NS4P
2	Magnetic Particle Filter	Mandatory on "H" Series Recommended on "J" Series*	---
3	Remote Controller	Supplied with Monobloc Unit	---
4	Tank Sensor	Supplied with a Panasonic DHW tank, if 3rd party tank used then has to be purchased separately (20m)	PAW-TS2
5	3 Way Valve	Mandatory if DHW tank installed	PAW-3WYVLV-HW
6	Room Thermostat (external)	Recommended (can be field supplied)	PAW-A2W-RTWIRED
7	G3 Kit	Mandatory (supplied with tank)	PAW-G3KIT
8	Circulating Pump	Mandatory (field supplied)	---
9a	200/70L DHW/Buffer Cylinder	Mandatory if DHW is required	PAW-TD20B7PP-UK
9b	300/70L DHW Buffer Cylinder	Mandatory if DHW is required	PAW-TD30B7PP-UK
10	Zone Water Sensor	Mandatory	PAW-AW-TSHC
11	Zone Room Thermistor	Mandatory	PAW-AW-TSRT
12	Mixer Valve	Mandatory (field supplied)	---
13	Buffer Tank	Mandatory (field supplied)	---
14	Immersion (Booster) Heater	Mandatory	---
15	Buffer Sensor	Mandatory	PAW-AW-TSBU

*"J" series has a small inbuilt magnetic particle filter.

2 Zone Wiring (Main PCB)

(See next facing page for additional PCB wiring)

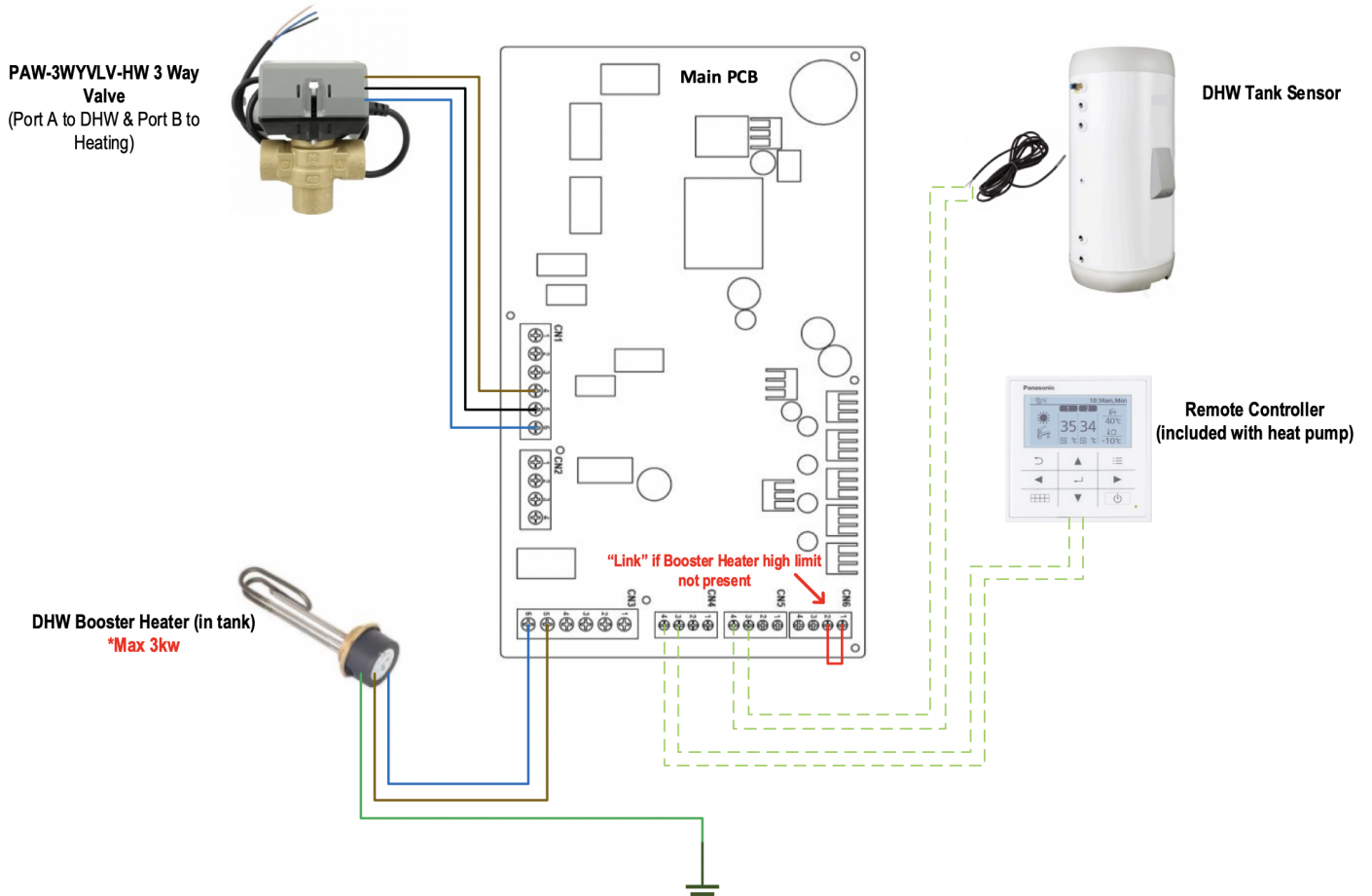

2 Zone Wiring (Optional PCB)

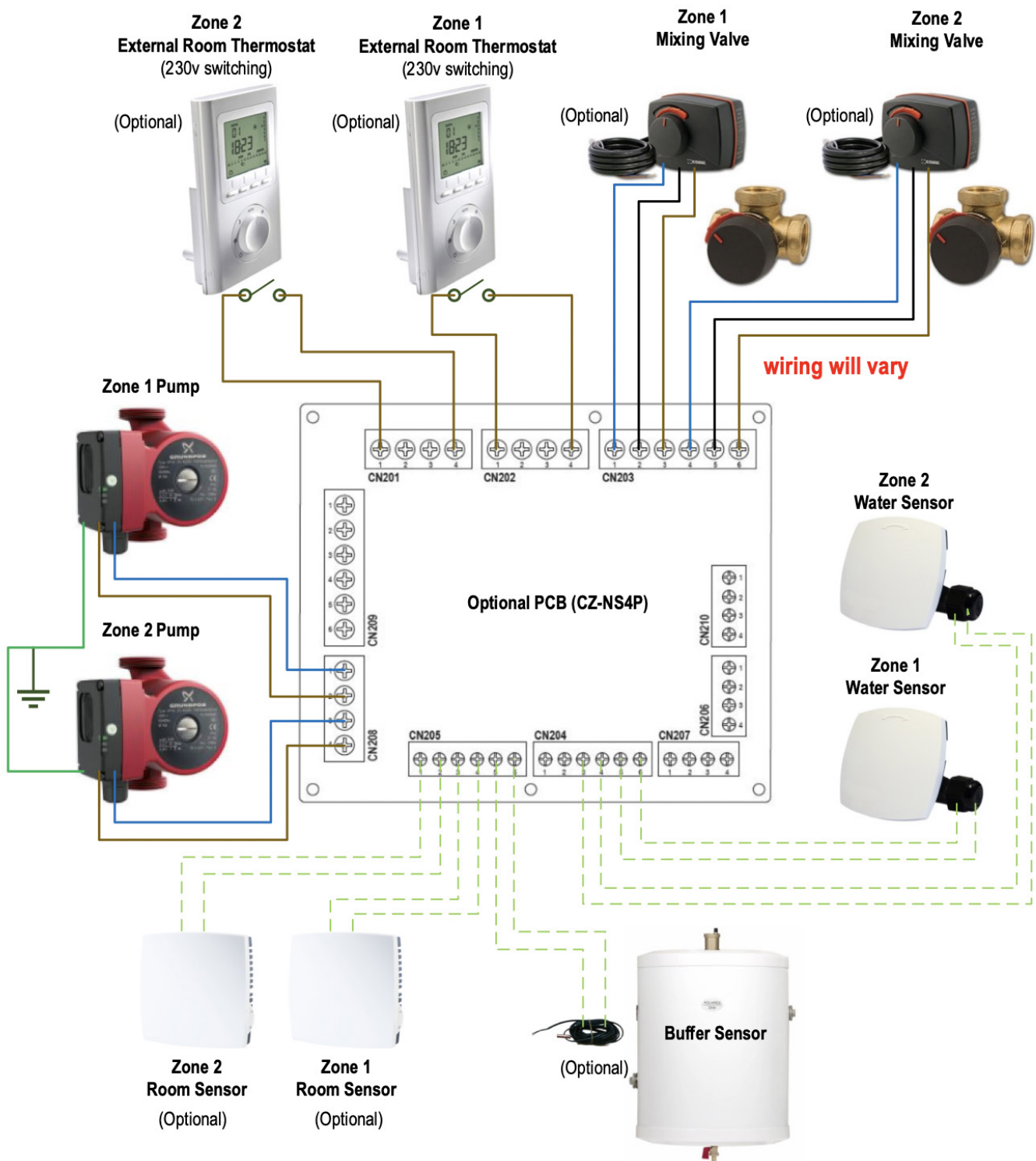

2 Zone Controller Setup

Step 1: Optional PCB Connectivity

2 zone configuration requires the Optional PCB (CZ-NS4P) to be physically installed and confirmed as being present in the system.

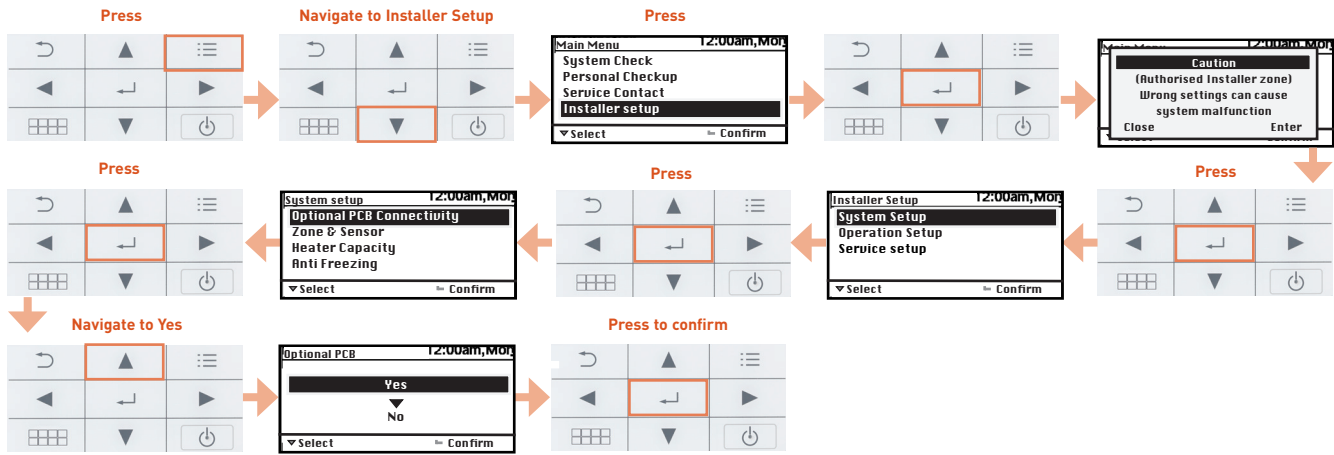

Step 2: Set Zone & Sensor Type

This is where you tell the heat pump that it will be connected to 2 zones and how it will be controlling them.

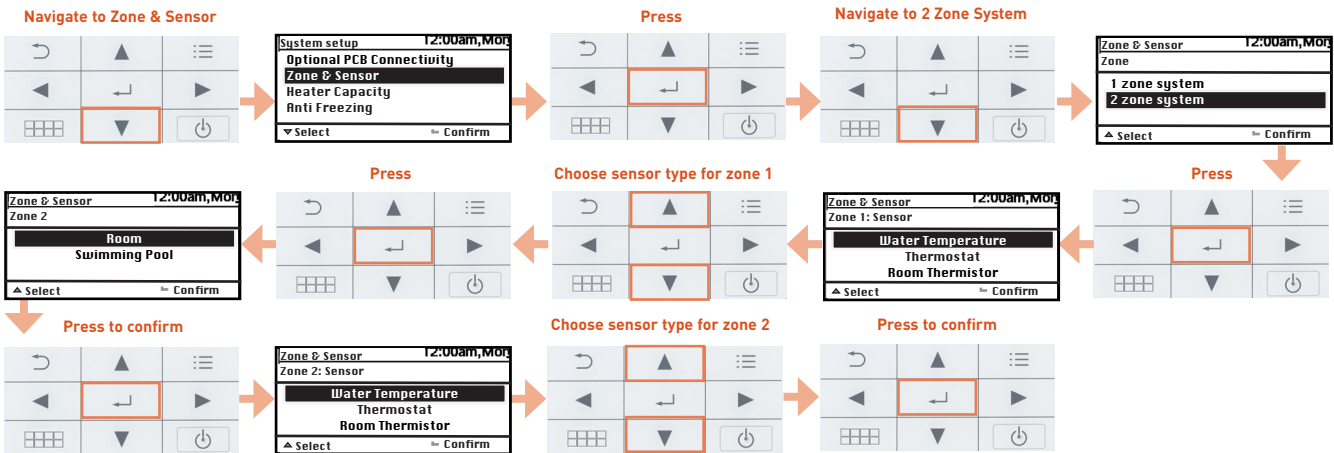

Step 3: Set Buffer Tank Sensor (optional)

This is where you tell the heat pump whether it will be monitoring the temperature of the buffer tank. The buffer tank can then be set to achieve a higher setpoint to that of the heating circuits. This is the Buffer ΔT, the difference in setpoint between primary and secondary sides.

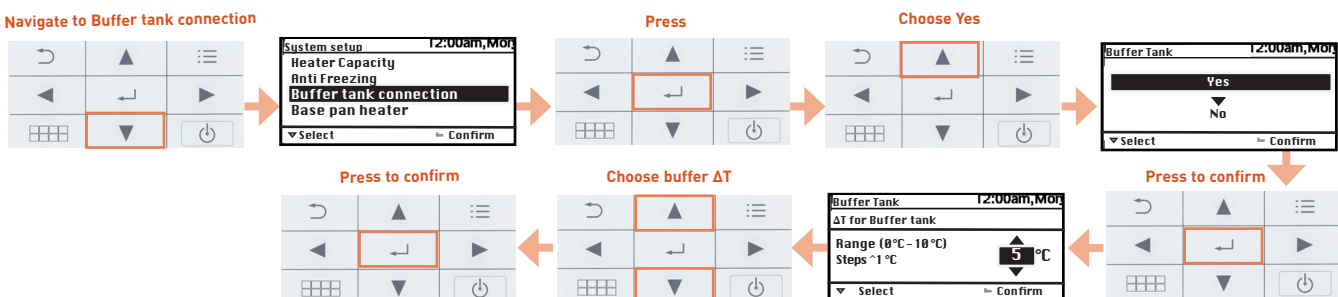

Step 4: Operation Setup (Heating Settings)

This is where you set whether the zone water flow temperatures will be direct (fixed flow temperature) or weather compensated. These settings are exactly the same as described previously for a single zone system. You just need to choose the settings for the second zone.

Both zones compensation curve:

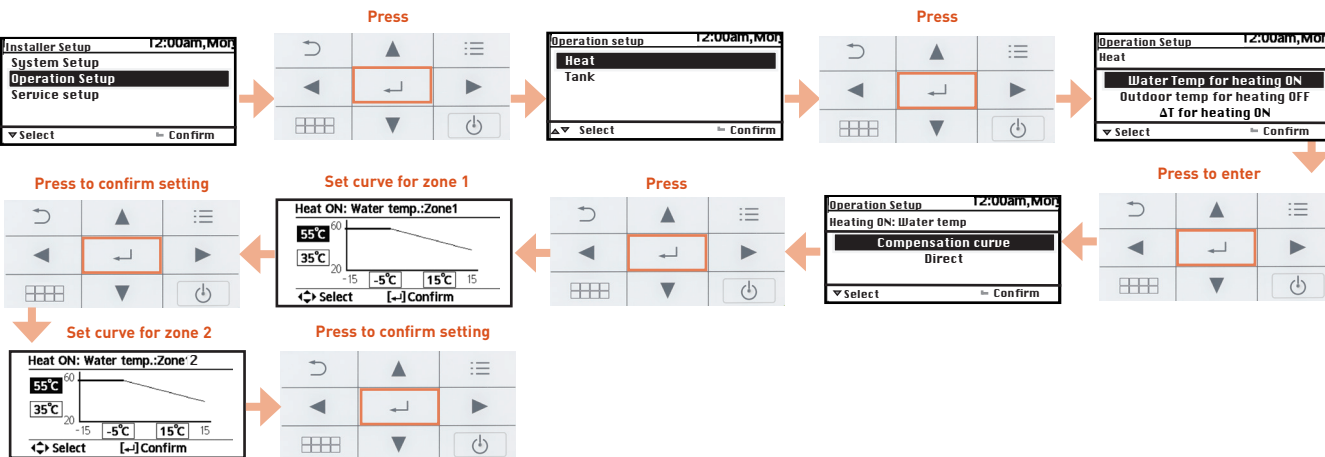

Both zones direct

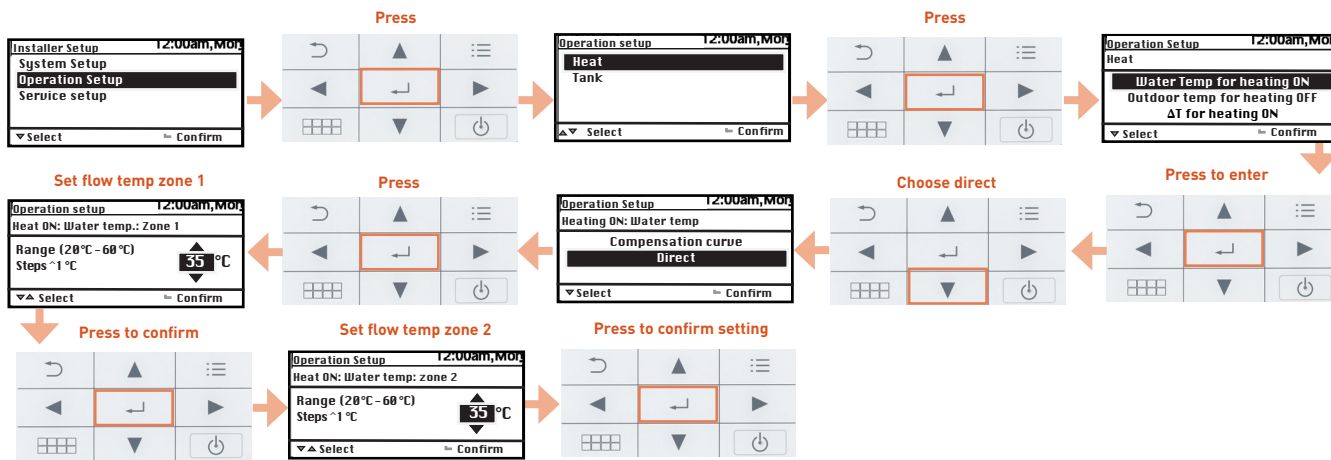

Operating 2 Zones

The main screen will vary depending on how the 2 zone system is being controlled. All functions are the same as a single zone system. The only difference is the inclusion of a second zone, which can be adjusted and switched on/off).

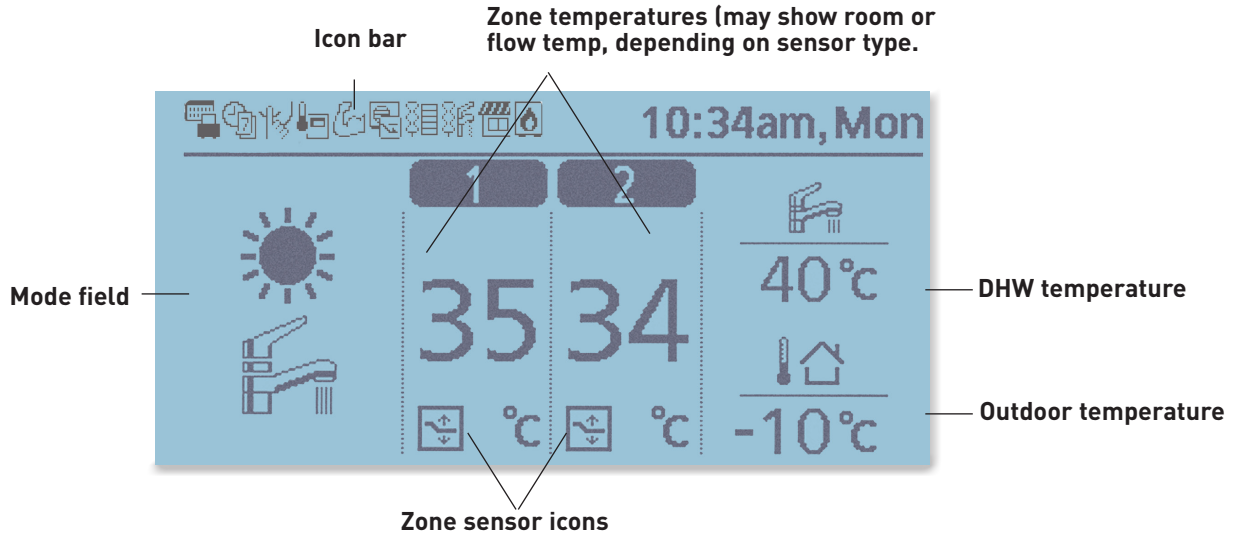

Room Thermostat
-> External

Room Thermostat
-> Internal

Water Temperature

Changing Zone Temperature:

This will depend on the zone sensor setting.

If set to "Room Thermostat (Internal)" or "Room Thermistor", the temperature shown will be the room temperature. This temperature can be adjusted from here.

If set to "Room Thermostat (External)", the temperature shown is the flow temperature. This temperature can't be changed here.

If set to "Water Temperature" and "Compensation Curve", the temperature shown is the flow temperature. The off-set can be adjusted. If set to "Water Temperature" and "Direct", the temperature shown is the flow temperature. This temperature can be adjusted from here.

Zone 1 Adjust

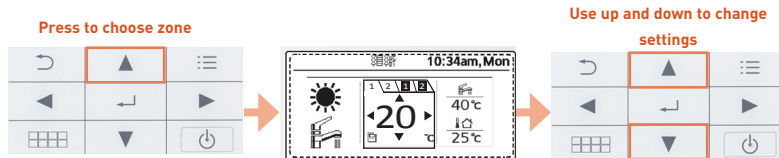

Zone 2 Adjust

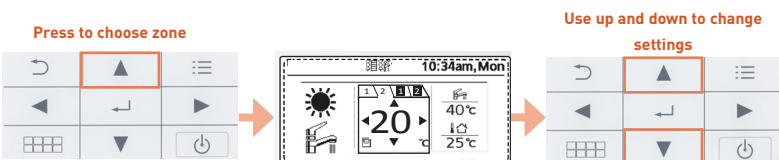

Switching Zone On/OFF:

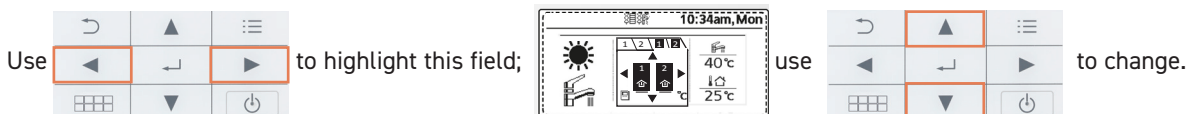

Zone 1 ON, Zone 2 ON

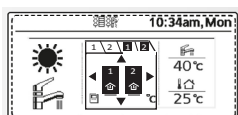

Zone 1 ON, Zone 2 OFF

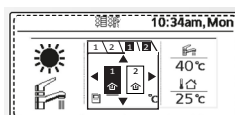

Zone 1 OFF, Zone 2 ON

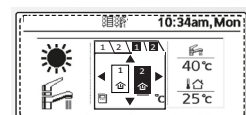

Mixing Valves

Mixing valves are used blend circuit temperatures up or down to the zones target flow temperature. This is often used when two zones require different flow temperatures (e.g. zone 1 is radiators and zone 2 is under floor heating). The heat pump is able to control 2 mixing valves (one per zone), if required.

Example

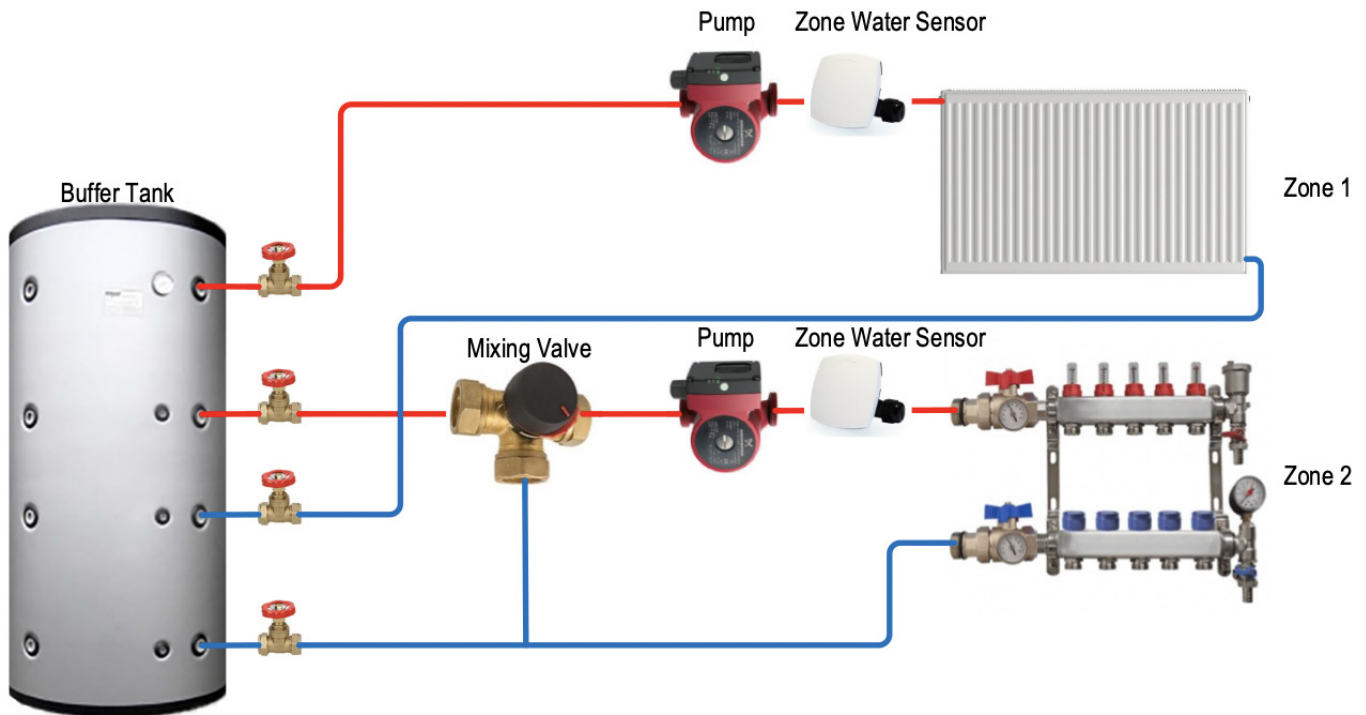

The system needs to know the flow temperature of circuit in order to make adjustments. This is why the zone water sensors are needed.

Fully Open: The valve is fully open to the buffer. The heating circuit receives the same temperature water from the buffer tank. No mixing from the return.

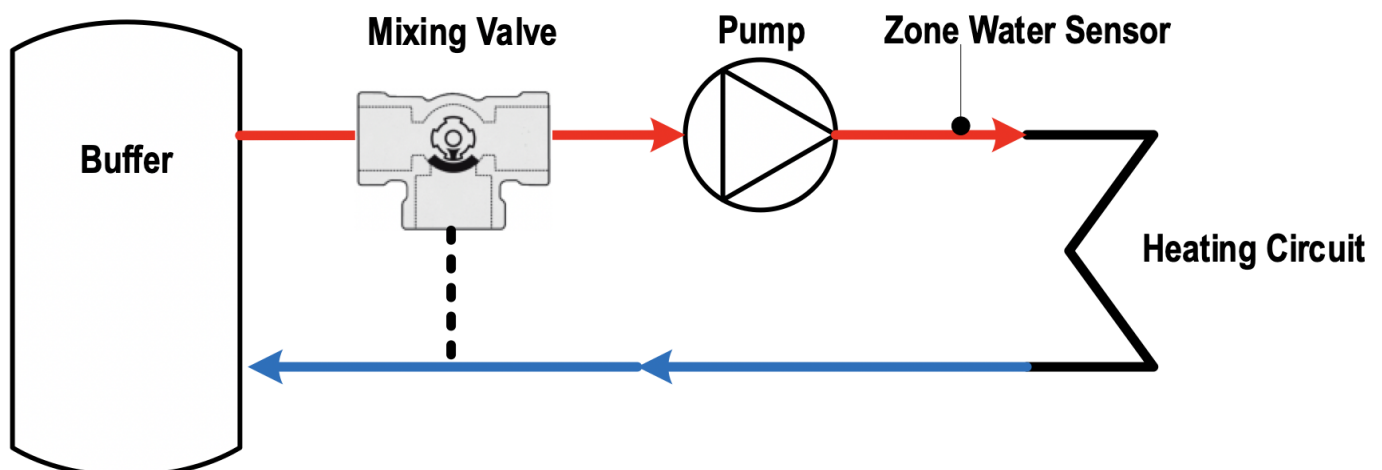

Mixing Valves

Fully Closed: The valve is fully closed off from the buffer. The heating circuit is circulating upon itself.

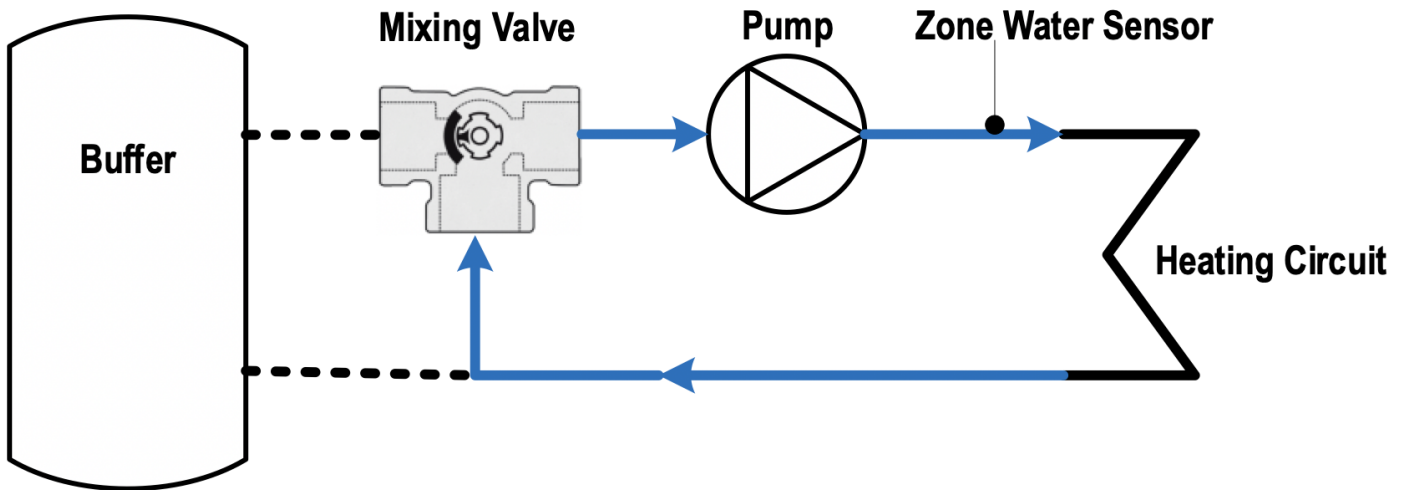

Mixing: The valve is open to both the buffer and return from the circuit. The flow temperature is blended down to the required temperature. The valve regulates itself to maintain a steady temperature.

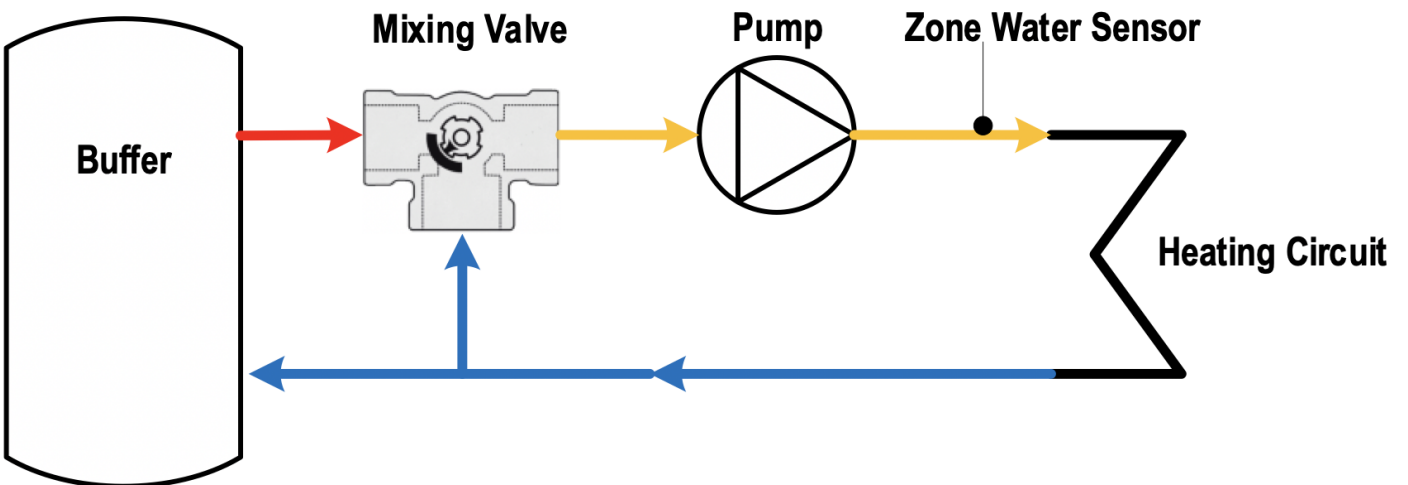

Wiring

Wiring will vary depending on the type and orientation of the valve. Usually 3 point control will be used, where control wires are energised alternately. The valve should be wired in such a way that when "O" is energised (230v), the shoe will rotate in the direction to close off the return port. When "C" is energised (230v), the shoe will rotate to close off the buffer port. The heating circuit port will always be open.

"O" (open) energised

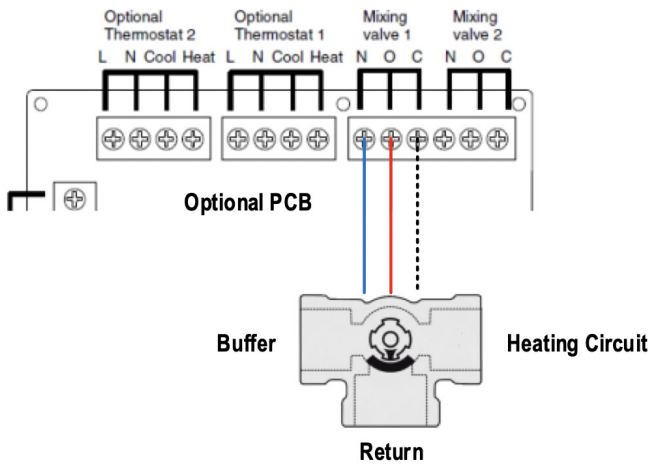

"C" (closed) energised

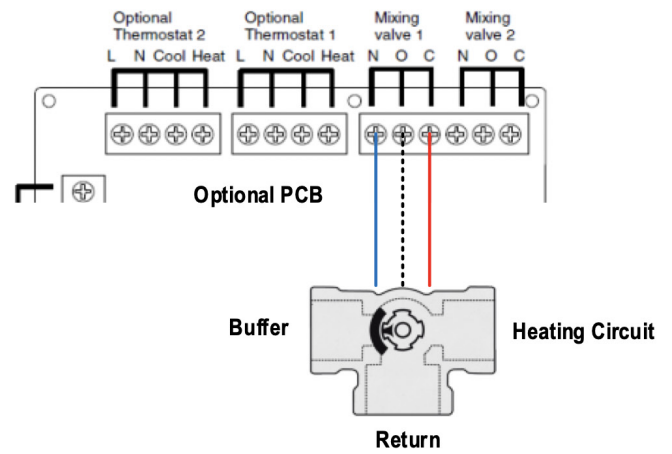

Advanced Installations

Bivalent Heating Setup

Aquarea is able to control a fossil fuel boiler as part of the heating system. The basic principle is that the heat pump will have full control of all aspects of the system and will run the backup boiler as and when required, depending on system design and settings. Zoning, solar, swimming pool or any other system control setup remains unchanged by bivalent control. The boiler needs to be connected into the system in parallel and preferably, into a buffer tank. The control signal, to the run the boiler, is made by closing a "dry contact" on the heat pump main PCB. The boiler operation and temperature is managed by the boiler controls. Ensure the system return temperature does not exceed 55°C. The heat pump simply gives a signal to run. The boiler is required to have its own circulating pump.

J series models also have the option to remotely enable/disable boiler or heat pump operation using 3rd party switch permutations (Smart Grid control. This will be explained.

There are 3 different bivalent control methods:

- **Alternative:** Heat pump and boiler operate independent of each other, never together. Once the outside temperatures drops below "Turn On" setpoint, heat pump stops and boiler takes over.
- **Parallel:** Heat pump and boiler can operate together. Once the outside temperatures drops below "Turn On" setpoint, boiler runs as well as heat pump.
- **Advanced Parallel:** Heat pump and boiler can operate together. Certain control conditions need to be met before boiler is signalled to run, which will be explained. Advanced Parallel configuration requires optional PCB (CZ-NS4P) and buffer tank sensor (PAW-A2W-TSBU).

Buffer tank sensor is not strictly necessary with "Alternative" or "Parallel" setups but it's recommended, as the system will function better. "Advanced Parallel" setups always require a buffer tank sensor and will not work without one. This guide will demonstrate layouts using a buffer sensor for all control methods.

Accessories that are needed for Bivalent installations:

- Optional PCB (CZ-NS4P)
- Buffer Tank Sensor (PAW-A2W-TSBU)
- Zone Water Sensor (PAW-A2W-TSHC) Note – 2 required for 2 zone setups

Installation Schematic

Basic Layout:

This layout uses a 4 port buffer tank, so the heat pump and boiler are connected in parallel. Non-return valves are required to avoid bypassing. The boiler must have its own circulating pump, which is controlled by the boiler. Boiler temperature is managed by the boiler controls.

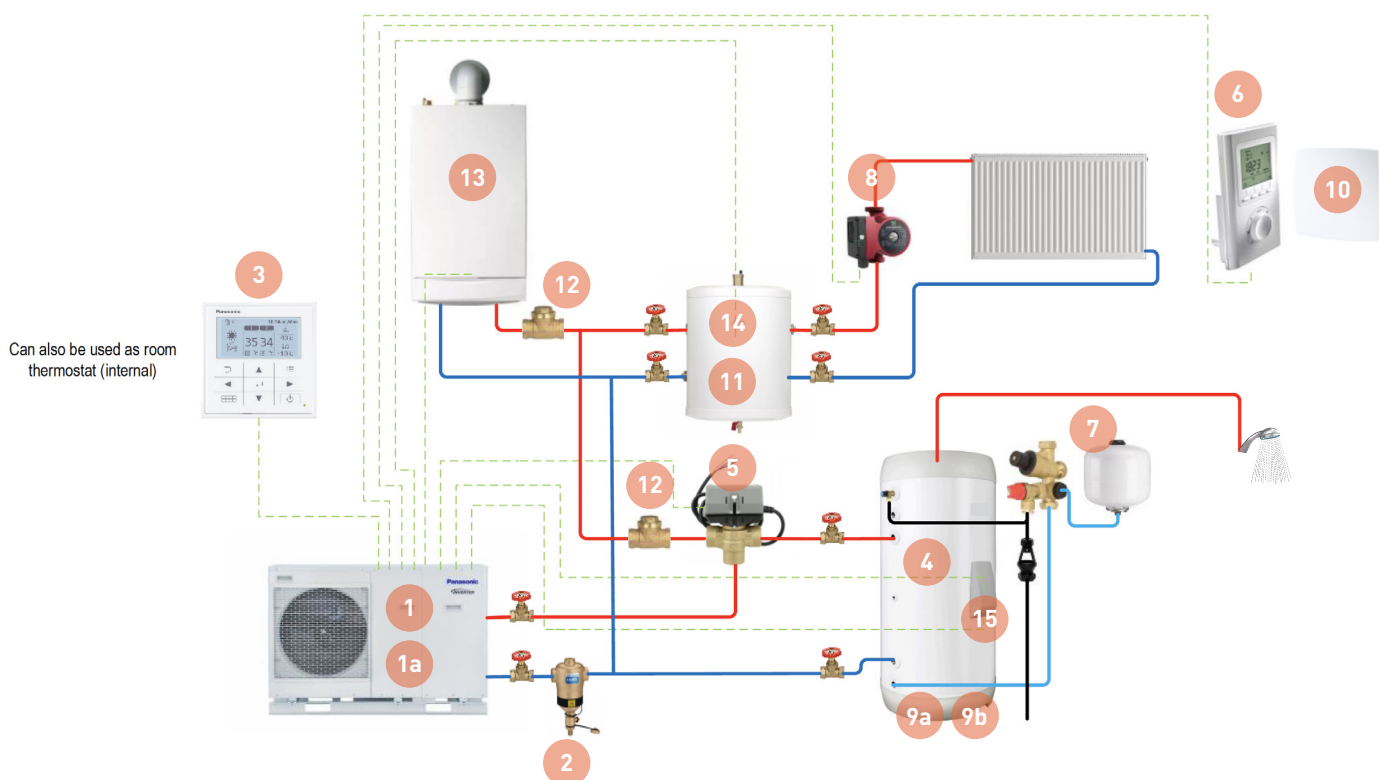

Number	Description	Type of Recommendation	Panasonic Part Number
1	Monobloc Unit	Mandatory	---
1a	PCB for advanced functions	Mandatory	CZ-NS4P
2	Magnetic Particle Filter	Mandatory on "H" Series Recommended on "J" Series*	---
3	Remote Controller	Supplied with Monobloc Unit	---
4	Tank Sensor	Supplied with a Panasonic DHW tank, if 3rd party tank used then has to be purchased separately (20m)	PAW-TS2
5	3 Way Valve	Mandatory if DHW tank installed	PAW-3WYVLV-HW
6	Room Thermostat (external)	Recommended (can be field supplied)	PAW-A2W-RTWIRED
7	G3 Kit	Mandatory (supplied with tank)	PAW-G3KIT
8	Circulating Pump	Mandatory (field supplied)	---
9a	200L DHW Cylinder	Mandatory if DHW is required	PAW-TD20C1E5-UK
9b	300L DHW Cylinder	Mandatory if DHW is required	PAW-TD30C1E5-UK
10	Zone Room Thermistor	Mandatory	PAW-AW-TSRT
11	Buffer Tank	Mandatory (field supplied)	PAW-BTANK50L-2
12	Non return valve	Mandatory	---
13	Boiler	Mandatory (field supplied)	---
14	Buffer Sensor	Mandatory	PAW-AW-TSBU
15	Immersion (Booster) Heater	Mandatory	---

Installation Schematic

Independent Buffer Connection:

This layout demonstrates the heat pump and boiler directly connected to the buffer tank independently. It also shows a direct 2 zone setup, which has no impact on the bivalent setup at all. Bivalent setup is the same for all system varieties. The boiler must have its own circulating pump, which is controlled by the boiler. Boiler temperature is managed by the boiler controls.

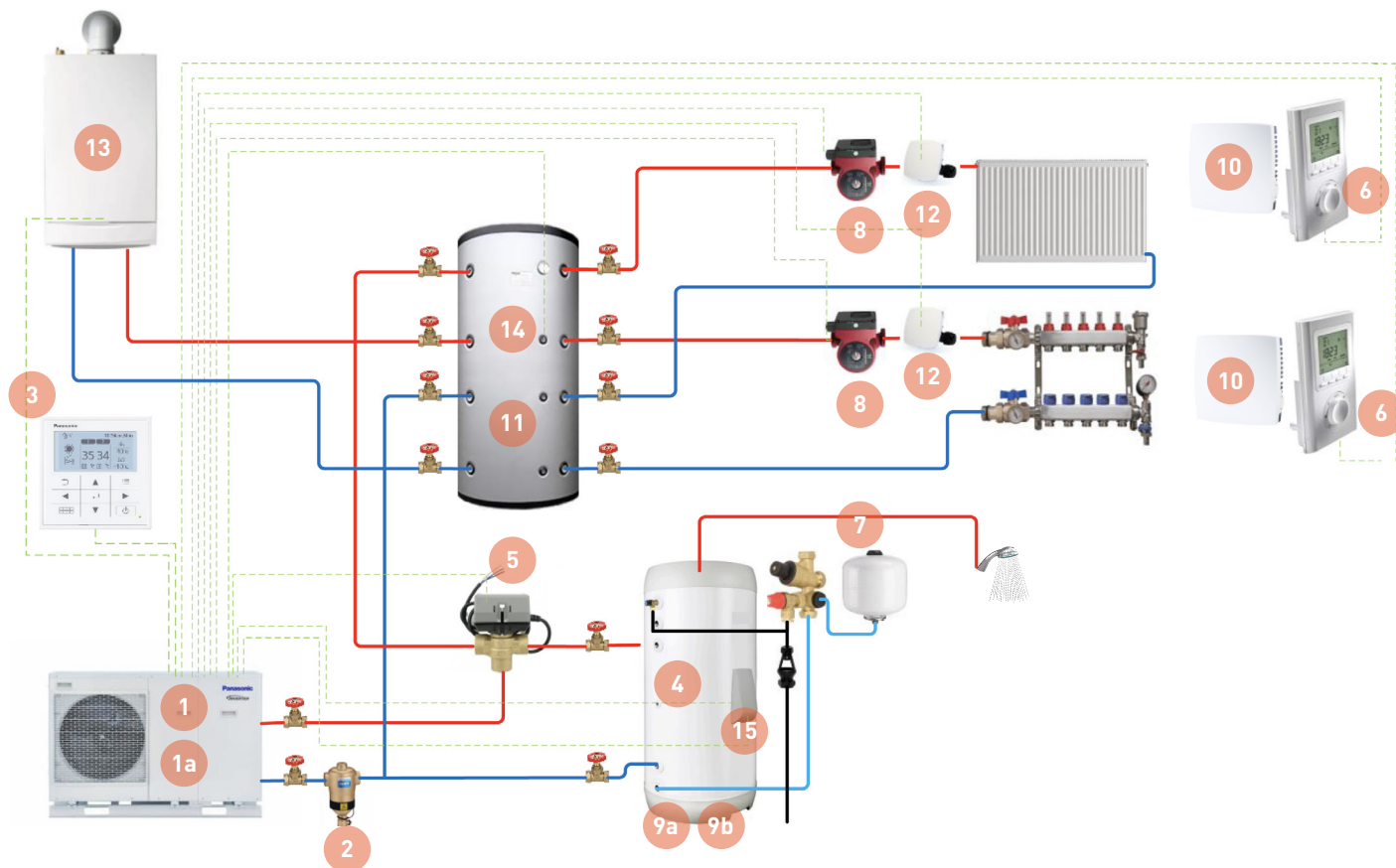

Number	Description	Type of Recommendation	Panasonic Part Number
1	Monobloc Unit	Mandatory	---
1a	PCB for advanced functions	Mandatory	CZ-NS4P
2	Magnetic Particle Filter	Mandatory on "H" Series Recommended on "J" Series*	---
3	Remote Controller	Supplied with Monobloc Unit	---
4	Tank Sensor	Supplied with a Panasonic DHW tank, if 3rd party tank used then has to be purchased separately (20m)	PAW-TS2
5	3 Way Valve	Mandatory if DHW tank installed	PAW-3WYVLV-HW
6	Room Thermostat (external)	Recommended (can be field supplied)	PAW-A2W-RTWIRED
7	G3 Kit	Mandatory (supplied with tank)	PAW-G3KIT
8	Circulating Pump	Mandatory (field supplied)	---
9a	200/70L DHW/Buffer Cylinder	Mandatory if DHW is required	PAW-TD20C1E5-UK
9b	300/70L DHW Buffer Cylinder	Mandatory if DHW is required	PAW-TD30C1E5-UK
10	Zone Room Thermistor	Mandatory	PAW-AW-TSRT
11	Buffer Tank	Mandatory (field supplied)	---
12	Zone Water Sensor	Mandatory	PAW-AW-TSHC
13	Boiler	Mandatory (field supplied)	---
14	Buffer Sensor	Mandatory	PAW-AW-TSBU
15	Immersion (Booster) Heater	Mandatory	---

Bivalent Wiring (Main PCB)

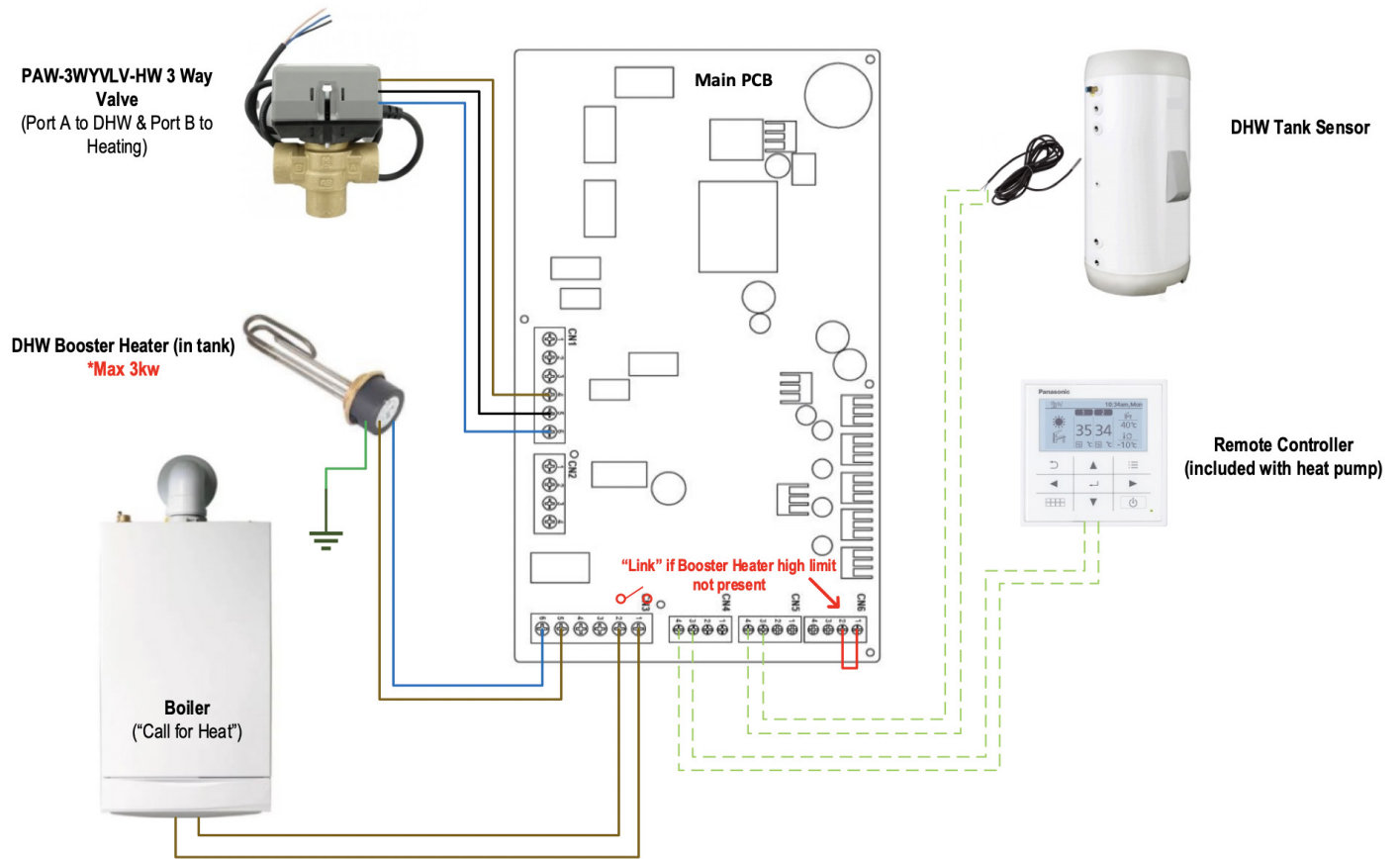

Bivalent Wiring (Optional PCB)

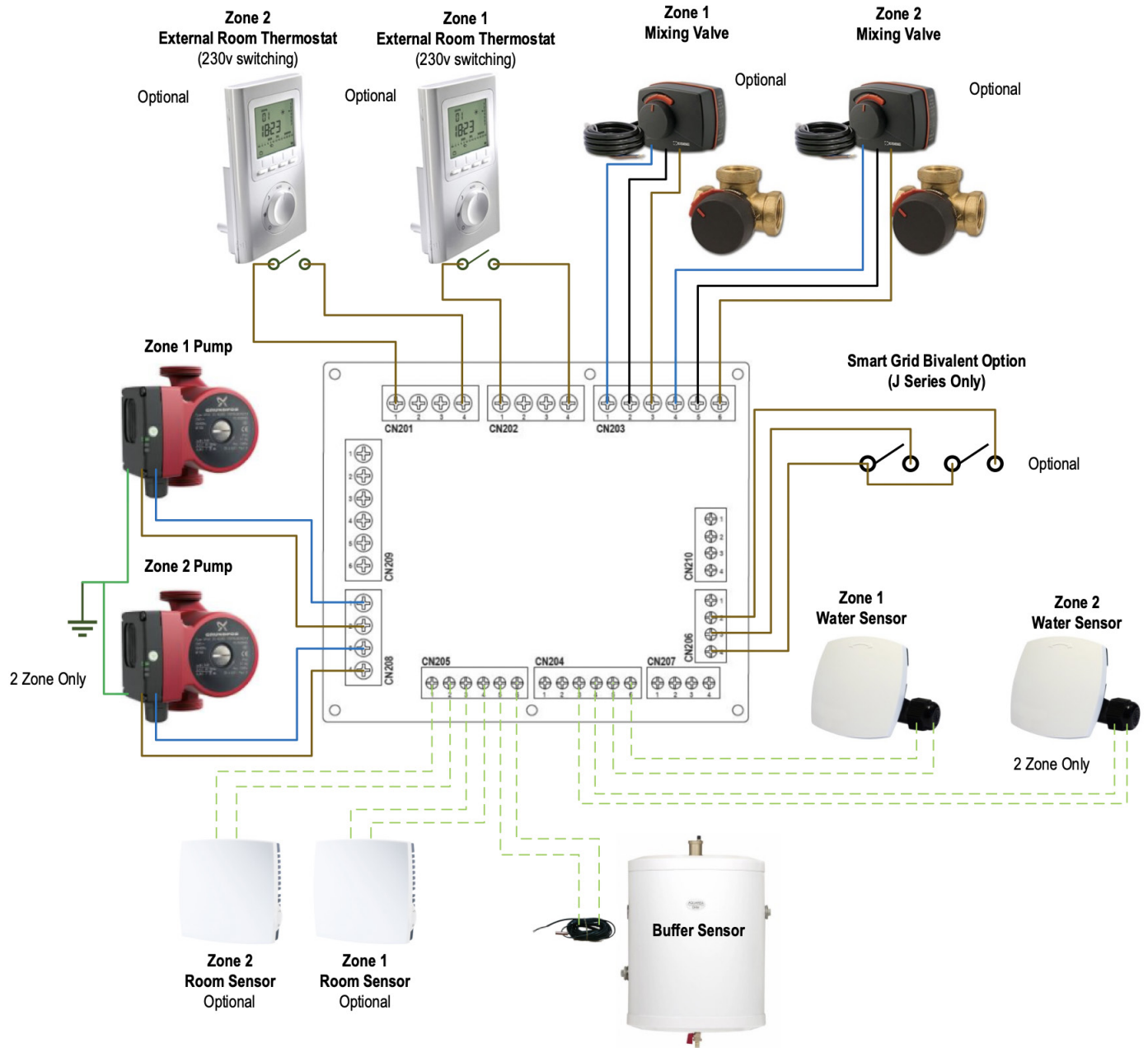

Bivalent Controller Setup

Step 1: Optional PCB Connectivity

Bivalent configuration with buffer tank sensor requires the Optional PCB (CZ-NS4P) to be physically installed and confirmed as being present in the system

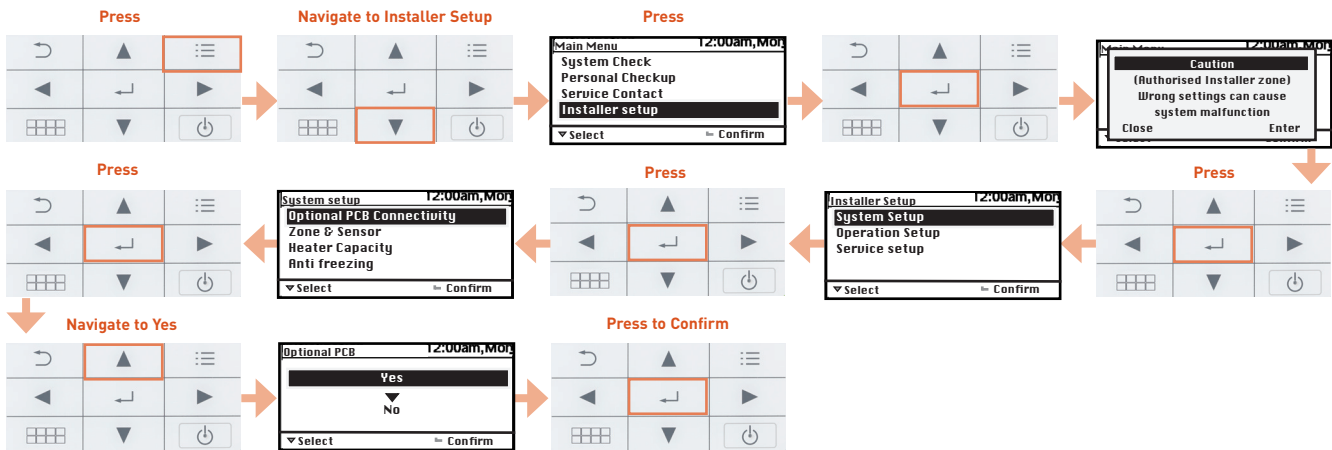

Step 2: Set Buffer Tank Sensor

This is where you tell the heat pump whether it will be monitoring the temperature of the buffer tank. The buffer tank can then be set to achieve a higher setpoint to that of the heating circuits. This is the Buffer ΔT, the difference in setpoint between primary and secondary sides.

The buffer target temperature will be the required zone flow temperature (highest temperature zone) + Buffer ΔT.

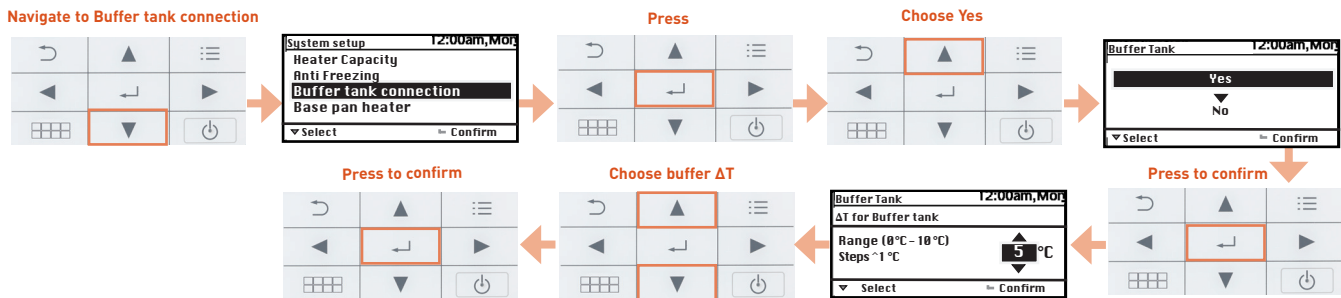

Step 3: Bivalent Settings

This is where you tell the heat pump that it will be controlling a boiler. This is also where you set the control conditions of the bivalent system. First of all, you need to decide which bivalent method is needed: Alternative, Parallel or Advanced Parallel.

Alternative: Heat pump and boiler operate independent of each other, never together. Once the outside temperatures drops below “Turn On” setpoint, heat pump stops and boiler takes over.

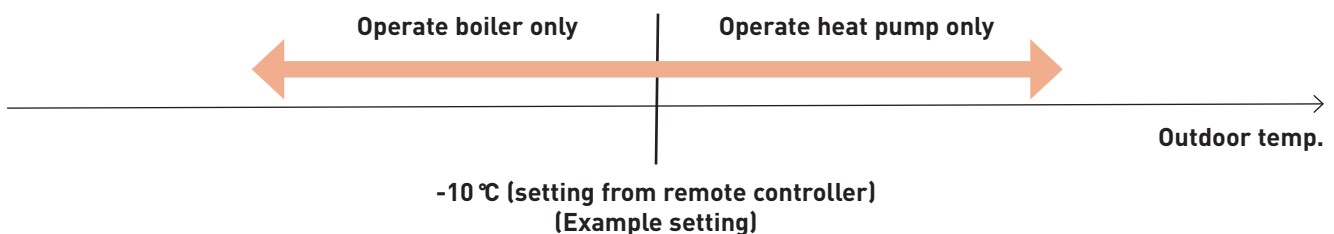

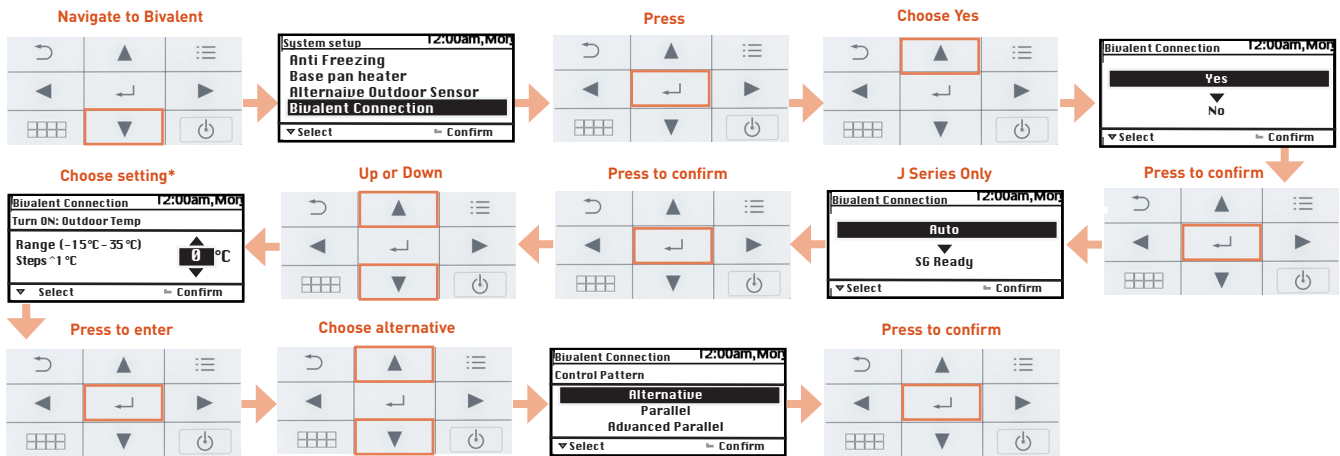

* "Turn On" set point: This is the setting at which the outside temperature must be at or below before bivalent operation starts.

Parallel: Heat pump and boiler can operate together. Once the outside temperatures drops below "Turn On" setpoint, boiler runs as well as heat pump.

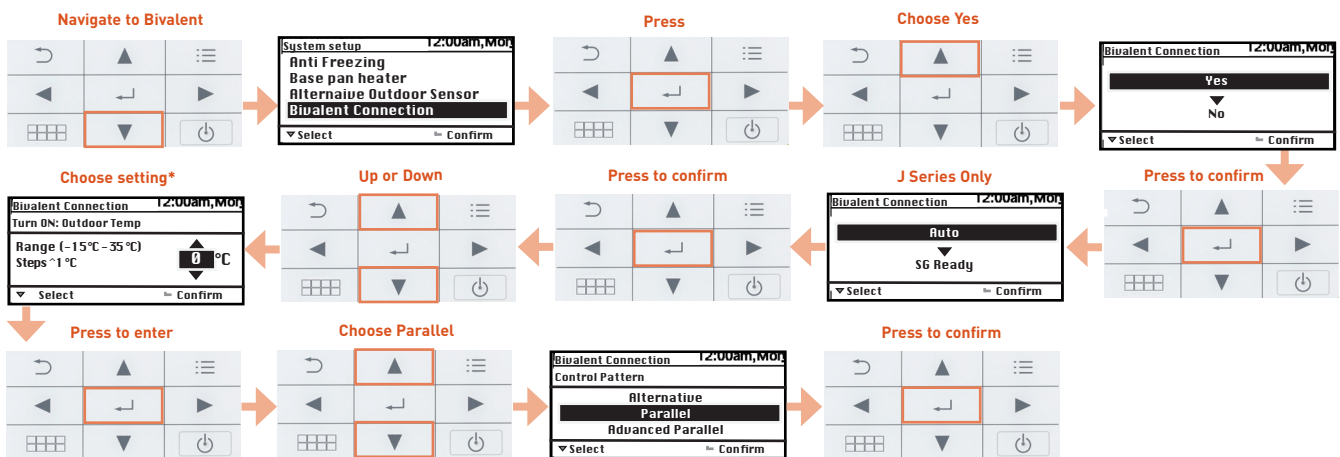
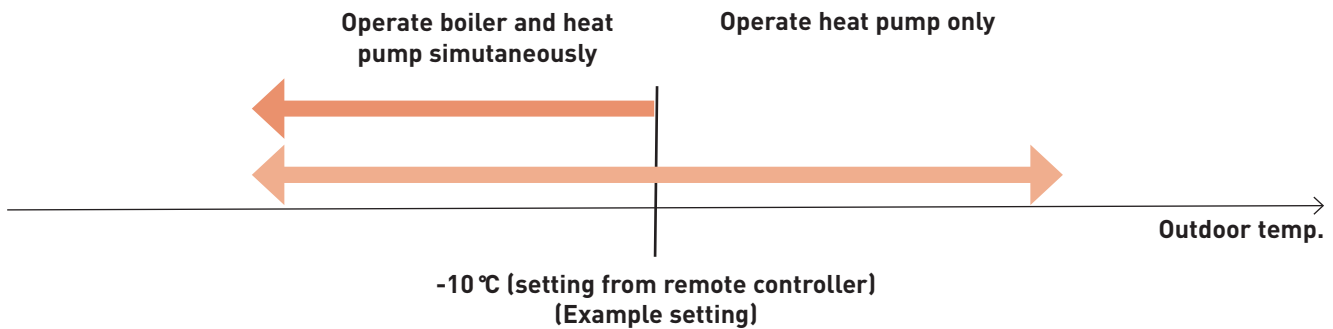

* "Turn On" set point: This is the setting at which the outside temperature must be at or below before bivalent operation starts.

Advanced Parallel: Heat pump and boiler can operate together. Certain control conditions need to be met before boiler is signalled to run. These conditions are:

Boiler signal turns ON when
 Outdoor ambient < Outdoor Ambient Set AND
 Buffer tank temperature < Target Buffer Tank Temperature + [START_TEMP] for [START_TIMER]

Boiler signal turns OFF when
 Outdoor ambient > Outdoor Ambient Set + [-2°C] OR
 Buffer Tank temperature > Target Buffer Tank temperature + [STOP_TEMP] for [STOP_TIMER]

On Temp: This is the setting at which the outside temperature must be at or below before bivalent operation starts.

Heat Start Target Temperature: This is the amount that the current buffer temperature must be below the buffer target temperature before "Heat Start Delay" timer will begin.

Heat Start Delay: The buffer temperature must remain at or below "Heat Start Target Temperature", for this delay time period, before the boiler is signalled to run.

Heat Stop Target Temperature: The amount the current buffer temperature must be within the buffer target temperature before "Heat Stop Delay" timer will begin.

Heat Stop Delay: The buffer temperature must remain at or above "Heat Stop Target Temperature", for this delay time period, before the boiler is signalled to stop running.

Although heat pump operates water temperature does not reach this temperature for more than 30 minutes (setting from remote controller)

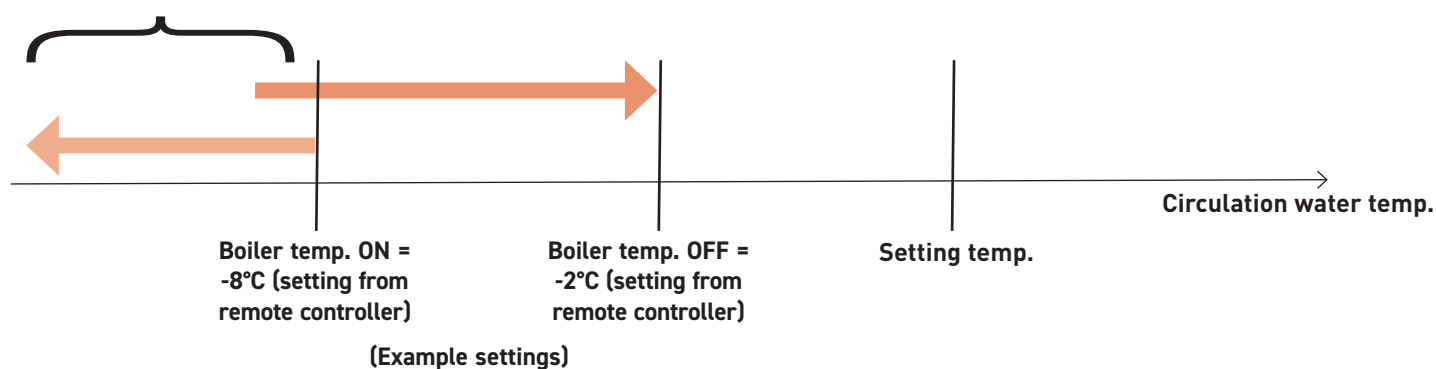

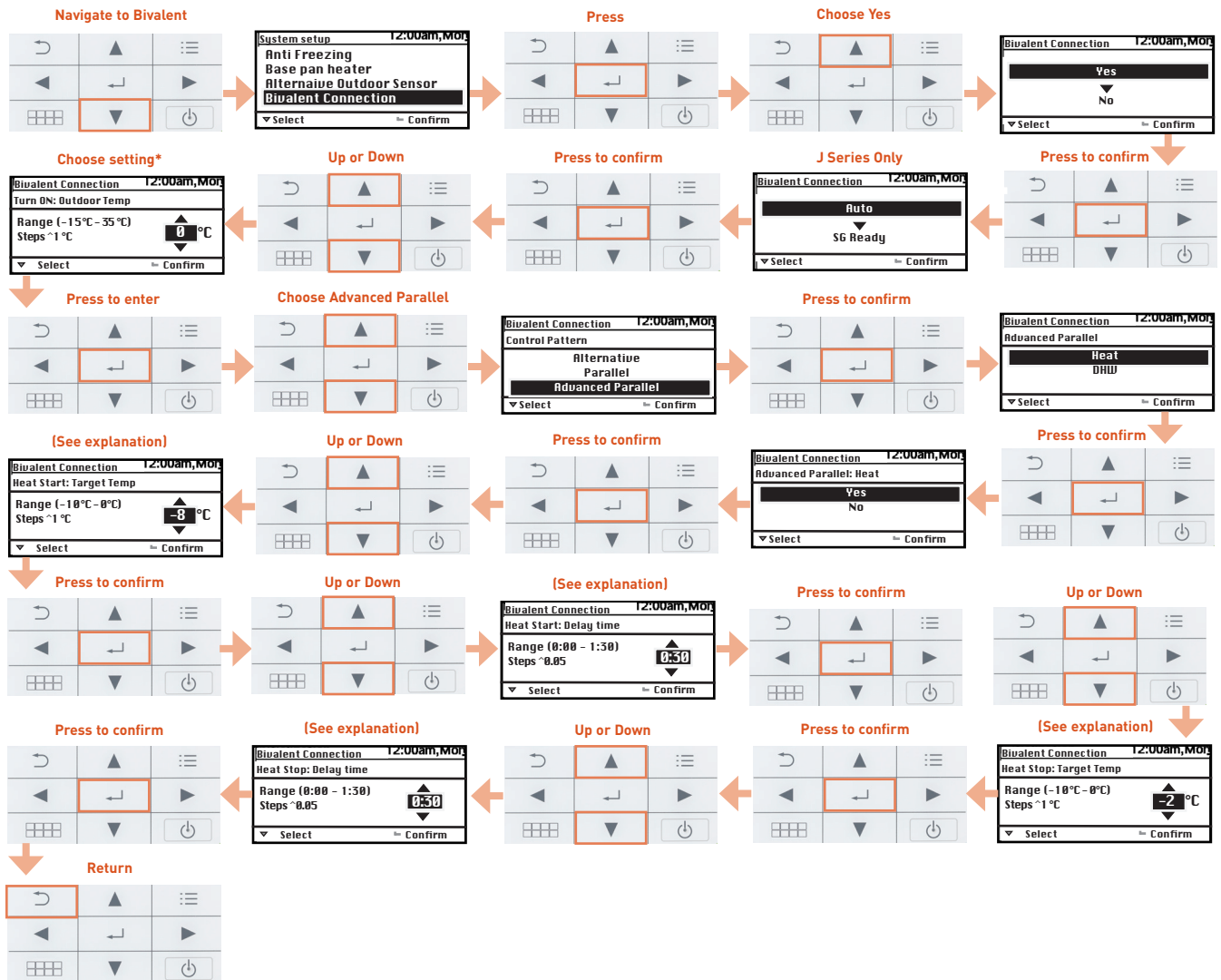

* "Turn On" set point: This is the setting at which the outside temperature must be at or below before bivalent operation starts.

Smart Grid (SG) Bivalent Option for J Series

It's possible to use external 3rd party inputs to remotely choose which heat source the system should use. This makes use of the smart grid switch inputs. These inputs allow 4 different options:

SG Signal Recommended RCD			Operation Pattern
	VCC-bit1	VCC-bit2	
1	Open	Open	Heat pump OFF, Boiler OFF
2	Short	Open	Heat pump ON, Boiler OFF
3	Open	Short	Heat pump OFF, Boiler ON
4	Short	Short	Heat pump ON, Boiler ON

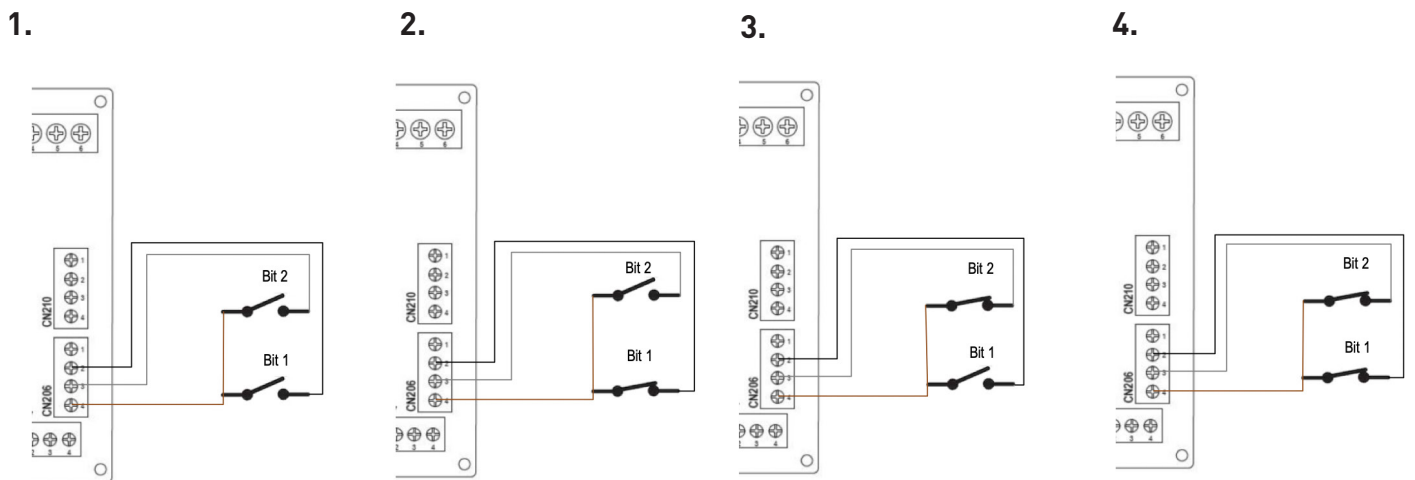

System must be set to "SG Ready" instead of "Auto" in Bivalent Setup menu.

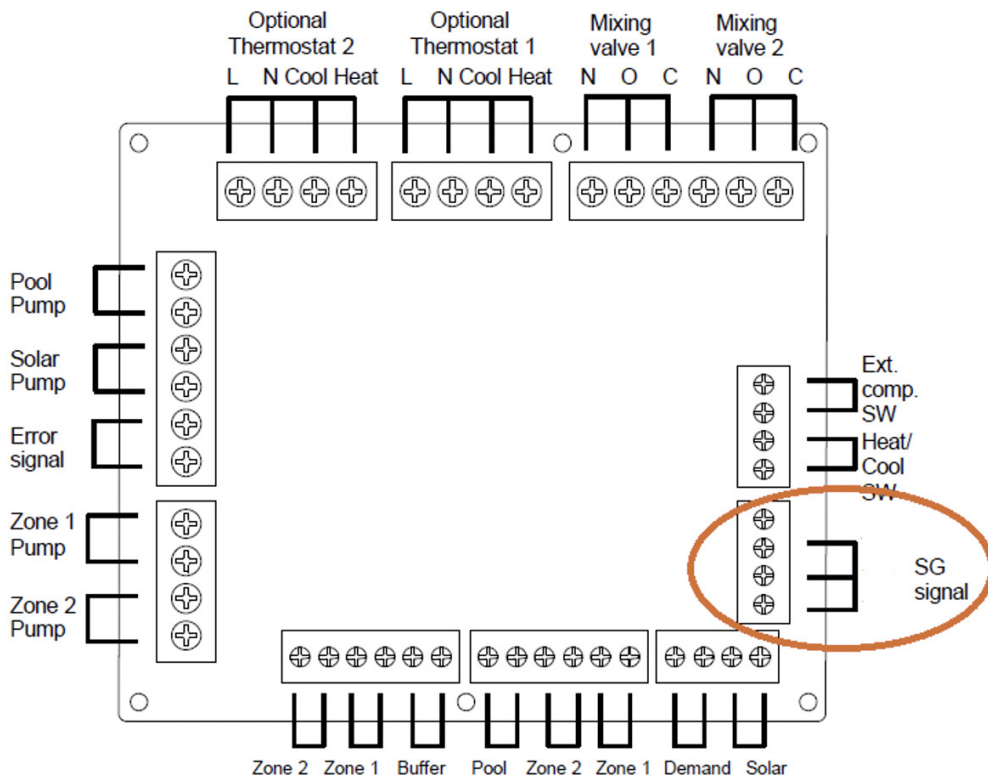

Accessories and Control

Buffer Tank



PAW-BTANK50L-2
Buffer tank for J and H Generation. Stainless Steel, tank sensor pocket, can be wall mounted.

Sanitary Tank accessories



PAW-TS1
Tank sensor with 6 m cable length.

PAW-TS2
Tank sensor with 20 m cable length.

PAW-TS4
Tank sensor with 6 m cable length and only 6 mm diameter.



CZ-TK1
Temperature sensor kit for third party tank (with copper pocket and m length sensor cable).

Special outdoor supports

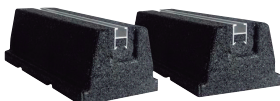

PAW-GRDBSE20
Outdoor base ground support for noise and vibration absorption (x x mm, kg).

Hydraulic accessories



PAW-3WYVLV-HW
3 way valve for DHW Tanks.



PAW-A2W-AFVLV
Anti-freeze valve.

Room Thermostats



PAW-A2W-RTWIRED
Wired LCD room thermostat with weekly timer.



PAW-A2W-RTWIRELESS
Wireless LCD room thermostat with weekly timer.

Connectivity Solutions



CZ-TAW1
Aquarea Smart Cloud for remote control and maintenance through wireless or wired LAN.

CZ-TAW1-CBL
10 m extension cable for CZ-TAW1.



PAW-AW-MBS-H
Modbus Interface for J and H Generation.

Sensors



PAW-A2W-TSOD
Outdoor ambient sensor.



PAW-A2W-TSRT
Zone room sensor.



PAW-A2W-TSHC
Zone water sensor.



PAW-A2W-TSSO
Solar sensor.



PAW-A2W-TSBU
Buffer tank sensor.

Warranty

Technical Helpline – 01344 853393

Email – uk-aircon-tech@eu.panasonic.com

Web address – www.aircon.panasonic.co.uk

GENERAL

The Heating & Cooling Solutions Warranty for Air to Water Products ("Warranty") is offered by Panasonic UK, a branch of Panasonic Marketing Europe GmbH, whose registered address is, Maxis 2, Western Road Bracknell, Berkshire RG12 1RT, UK ("Panasonic").

The Warranty is offered in the United Kingdom ("UK"), including Northern Ireland, the Channel Islands, Isle of Man and the Republic of Ireland (the "Area"). This Warranty is an addition to, and does not in any way affect, any statutory or other rights.

The Warranty periods detailed within this document apply to installation carried out within the Area only. If the country of installation is different to the country of purchase, the Warranty will be provided in accordance with the terms and conditions applicable in the country of installation. By subscribing to this Warranty end users will be deemed to have read and accepted these Terms and Conditions. These Terms and Conditions are governed by and construed in accordance with the laws of England and Wales.

CONDITIONS OF COVER

The Warranty covers the Panasonic Heat Pump system(s), cylinder(s) and ancillaries ("Product") when installed by a suitably competent, qualified and trained installer, contractor or engineer ("Installer"), in accordance with the Panasonic Heating & Cooling Solutions ("Panasonic") Installation Guidelines and Recommendations provided with the Products.

Panasonic reserves the right to amend the Warranty conditions and cover from time to time, subject to a minimum period of one month's notice, which will be published on the Panasonic Website.

This Warranty resides with the Product and will remain with the Product, but is limited to the original site of installation in which the Product is installed, and applies to the original site and positioning of installation only ("Property"). This Warranty may be transferred to a new Property owner, or user ("End User"), provided the Product is not moved from the original site and positioning of installation, unless carried out by a Panasonic approved Installer. This Warranty is offered on the condition that the Product is properly maintained in accordance with Panasonic Maintenance Guidelines as published on www.panasonicproclub.com/

Panasonic offers three types of Warranty coverage; 3 Year Standard Warranty ("Standard Warranty"), 5 Year Extended Warranty ("Extended Warranty") and 7 Year Extended+ Warranty ("Extended+ Warranty"), for Products purchased from an approved reseller ("Distributor"). (List available upon request, approved companies may be found at www.aircon.panasonic.co.uk) ("Website"). The Extended Warranty and Extended+ Warranty are only available to the Installer who meets with the conditions detailed within the Warranty Type and Criteria section.

The Warranty period, will commence within 3 months of the date of commissioning, or 6 months from sale by Panasonic and no later than 18 months from date of manufacture, whichever is sooner. For Extended+ the warranty documentation must be submitted via the Service section of the Panasonic website www.panasonicproclub.com ("PROclub") within 3 months of the date of commissioning, or 6 months from sale by Panasonic and no later than 18 months from date of manufacture, whichever is sooner.

WARRANTY TYPE AND CRITERIA

For the Warranty to be valid, the Installer must have the required expertise to fit the Product or ensure that a relevant installer with the necessary expertise's carries out the installation.

The Installer must have a relevant knowledge and understanding of the installation of A2W systems, and where applicable, be F-Gas qualified, or have a relationship with a local qualified F-Gas qualified installer to enable the installation of bi-bloc and all in one heat pump systems. Fault finding on Panasonic Heat pumps will also require F-gas qualifications or working relationship with a local F-Gas qualified Engineer.

The Installer must complete a Panasonic certified Pro Partner training course for the A2W Products if they wish to be able to supply the End User with a 5 year Extended

Warranty. The training may be provided by Panasonic directly or by a Panasonic accredited training centre/distributor. Upon successful completion of the training course, Panasonic will issue a Training Certification Code ("TCC"), which may be requested, for the purpose of verification, during a Warranty claim. The TCC will be valid for a period of 36 months from the date of issue. Installations must be carried out by an Installer who has successfully completed the aforementioned training. The Installer will be required to attend range specific training in order to qualify for being able to provide the End User with an Extended Warranty for specific a Product range. The TCC will commence from the date of initial training. From time to time, additional training may be required in order to comply with warranty amendments and new Product introductions.

In order to obtain the 7 year Extended+ Warranty, the Installer must fulfil all requirements of the Standard and Extended Warranty and in addition, the relevant project(s) must be submitted to the PRO Club via the Warranty submission portal. Details of the installation must be provided including but not limited to: the installation address, Installer details, supplying Distributor, the Installer's TCC and a fully completed Panasonic approved commissioning sheet. The Extended+ Warranty registration documentation must be provided by the Installer. Incomplete and or incorrectly completed documentation will be returned to the Installer for completion. The fully completed documentation must be resubmitted within 30 days of issue, or the Product will be eligible for the Extended Warranty only. It is the responsibility of the Installer to ensure the documentation is completed and returned. Panasonic will provide guidance on any incomplete / incorrect details and reserves the right to provide clarification of the Product installation prior to acceptance.

Please ensure full contact details are provided to allow contact to be made readily. Panasonic holds no responsibility for the failure to provide adequate contact details resulting in the late submission of a warranty registration.

For the avoidance of doubt, Panasonic reserves the right not to offer (or to withdraw) any Warranty in respect of submitted Warranty documentation that is deemed incomplete, inaccurate or containing any misrepresentation or otherwise unsatisfactory.

To meet the requirements of the Standard Warranty, which is for three years and covers parts only, the product must be installed, maintained and serviced annually by a suitably trained and qualified engineer and service records kept. In order to meet the requirements of the Extended and Extended+ Warranty, the Product must be maintained by a competent service company and service records kept. If this is not adhered to the Warranty will revert to a 3 year Standard Warranty assuming the Standard Warranty maintenance guidelines have been met. Records of all maintenance must be kept and be

available for inspection by Panasonic prior to any Panasonic service/repair Warranty work being carried out. Failure to maintain the system or keep adequate records of maintenance will invalidate the Warranty.

LIABILITY

What is covered.

From expiration of the national statutory warranty, the Standard Warranty will cover the Product for a further two years (three years total), the Extended Warranty will cover the Product for an additional four years (total period five years), and the Extended+ Warranty will provide a total period of seven years (six years in addition to the statutory). The warranties cover breakdowns due to initial

manufacturing defect of the Product only. The Extended Warranty (five and seven years) covers the costs for spare parts and fixed labour allowance relevant to the item repaired. The labour allowance is up to a maximum amount of an equivalent replacement of the Product.

What is not covered.

Panasonic accepts no liability for the workmanship of the Installer. All Installers including PRO Partners are independent of Panasonic and any cause of action for Installation shall not be against Panasonic but against the individual Installers. For the avoidance of doubt, Panasonic is not liable for any pipework, connections, ancillary equipment or controls that are connected to the Product that are not supplied by Panasonic.

Panasonic do not provide indemnified designs unless agreed in advance of installation, and any indemnified designs will be provided via a fully insured third party. Any design guidance provided is for general guidance only. It is the responsibility of the Installer or designer to ensure the Product meets with the requirements of the Property.

Panasonic will not under no circumstances let any replacement parts or any warranty work carried out by a third party or by Panasonic lead to an extension of warranty or an extension of the original warranty expiration date.

Panasonic is not liable for any consequential or economic loss, howsoever arising from any defects affecting the Product or from any delay in repairing or replacing the Product. Panasonic are not liable whatsoever for any fault or costs of repair resulting from: incorrect selection and/or installation of the equipment, including defective design and/or application, inadequate commissioning, inappropriate maintenance or neglect, accidental and/or deliberate damage, misuse, normal wear and tear and any unauthorised alteration or repair; the costs of any ordinary or specified product maintenance, and costs and/or faults resulting from any other use but the purpose the Products are intended.

Panasonic accepts no liability for and excludes from the warranty the following;

1. Misrepresentation contained within submitted warranty documentation;
2. Parts subject to wear and tear (included but not limited to, filters, glycol, inhibitors, electrodes, anodes, batteries, fuses, gaskets and sealing materials), which are to be replaced during service work according to the details of the manufacturer guidelines;
3. Damage or failure to the withdrawal of services by a third party;
4. Failure due to excessive dirt, dust or materials affecting the normal operation of the system;

5. Failure of third party equipment resulting in a defect or failure within the product;
6. Element failure due to scale build-up;
7. Environmental conditions or pollutants resulting in excessive degradation of the Product materials (including but not limited to; rust, coil failure, electrical sheathing);
8. Incorrect selection or erection of equipment, incorrect fixtures and fittings, unsuitable electrical protective devices or wiring systems, unstable or unsuitable mounting locations and insufficient access for maintenance or repair;
9. Repairs of purely visual faults, which does not affect the functionality of the devices (e.g. scratches and signs of wear), unless advised at the time of installation and where there is clear evidence of transport damage not identified at the time of delivery (additional proofs may be required);
10. Damages caused by improper or deliberate action (including but not limited to filling of the respective Product with contaminated liquids or gases, or operating substances not considered by the manufacturer);
11. Failure due to the incorrect or unstable electrical supply (including temporary supplies from generators);
12. Faults resulting from an alteration to the original design of the Product;
13. Faults due to misuse in conflict with the manufacturer's guidelines and recommendations Damage due to deliberate destruction (e.g. vandalism) or animal bites;
14. Natural hazards caused by storms, frost, corrosion, lightning, excess voltage, earthquakes, high water levels, hail, landslides, flooding, explosion, nuclear power accidents, fire, war events, terrorism or similar;
15. Failures not related directly to the Product (wrong settings, wrong installation due to non-Panasonic equipment, etc.);

MINIMUM INSTALLATION REQUIREMENTS

It is the responsibility of Installer to ensure system volume and flow rates meet with the nominal levels detailed within the installation manual provided with the unit. The installation must also meet Local/British domestic compliance guidelines. Failure to meet the minimum flow may result in poor performance, system errors, component failure, reduction in system longevity and could deem the Warranty void upon inspection by Panasonic or an independent Panasonic approved engineer.

All electrical wiring, piping and ancillary installation, must be carried out in accordance with the local regulations. Failure to meet the minimum legislative requirements/ domestic compliance guidelines will invalidate the Warranty.

Suitable isolation must be provided to allow safe working of the Product in the event of a failure. Panasonic will not be held responsible for a system that cannot be suitably and safely isolated in order to carry out and inspection or affect a repair.

Panasonic reserves the right to refuse to carry out any reparations and/or works deemed unsafe due to lack of suitable isolation, and may recover costs for an aborted visit.

For A2W, in order to comply with the Warranty conditions the following minimum conditions must be met:

- Strainer installed in return flow as close as possible to system inlet, with mesh weave no greater than 600 microns (30 mesh) - (pre- fitted within the H series onwards A2W systems);
- For Panasonic Heat Pumps up to and including H Series, a magnetic filter must be installed within the return flow, as close as possible to the heat pump system inlet. For these models the filter must be cleaned during annual maintenance. For the J series Heat Pump onwards there is a pre-installed internal magnetic filter which shall be cleaned during annual maintenance in accordance with the installation manual provided with the unit.
- As specified within the Installation manual, minimum primary flow rates and primary system volume for the unit installed must be achieved.

WATER QUALITY

Panasonic A2W must be fitted to a closed water system only. Failure to install to a closed water system may result in excessive corrosion and leads to the risk of introducing foreign materials into the system which may cause damage and improper operation. The water quality for supply to hot water cylinders shall be in accordance with European Council Directive 98/83 EC, or revised version at the date of installation, and water provided to the closed system shall comply with water quality standard guidelines for A/C and refrigeration equipment (JRA-GL 02-1994) The parameter quality limits for tap water on the secondary side can be found in the installation documentation supplied with the product.

If fed with water from a private supply, then a test report shall be carried out to confirm the water is within the minimum parameters of the water quality as stated below.

- Chloride content: Max. 200 mg/l
- Sulphate content: Max. 200 mg/l
- Combination chloride/sulphate: Max. 300 mg/l (in total)

Glycol / Antifreeze

Any damage to a Panasonic Monobloc heat pump caused by freezing is not covered under the Warranty. It is the responsibility of the Installer to determine and implement applicable preventative measures (if required) to reduce the risk of pipes freezing. Please note that freezing could cause damage to the heat pump. Guidance is provided in the installation manual. However, please note that the guidance is general and Installers are required to relevantly assess the measures for specific local conditions. Installers should consider commissioning data collected during annual maintenance visits and local conditions to assess and implement requirements. Please note, Panasonic take no responsibility, and have no liability, for Installers action or inaction in this regard

MAINTENANCE

The Product is subject to a periodic maintenance regime (minimum 12 months), in accordance with the Manufacturer Maintenance Guidelines as defined below. It is the responsibility of the End User to demonstrate the regular maintenance and inspection of the system. Inspection and maintenance must be carried out by a suitably trained and qualified engineer. In accordance with the regulatory guidelines relating to the maintenance of refrigerant systems and the Manufacturer Guidelines, the periodic maintenance shall include, as a minimum, the following inspections points:

1. Visual inspection of system integrity, cleanliness and general system condition, structure and support of the Product and where appropriate affect a repair;
2. Verification of lagging / insulation materials.
3. Verification of electrical integrity, protective devices, integrity of wiring and earthing systems, cable connections, and where applicable tightening, reconnecting, re-terminating, or replacing accordingly.
4. Leak detection test (refrigerant and water);
5. Testing of components; including but not limited to fan motors (bearings and rotation), condensate systems (motor / pump operation, pipework and drain capability), outdoor unit evaporator condition (care must be taken when cleaning, so as to not damage fins), safety valve test (hydraulic), cleaning of filters and strainers (hydraulic), pressure vessels and pressure relief devices (hydraulic), external thermostatic controls (hydraulic), valves operation (hydraulic);
6. Inspection and verification of glycol / inhibitor condition (hydraulic);
7. Verification of system operation against original commissioning data, recording system operation (liquid, suction and discharge temperatures / pressures where applicable), thermistor readings for both internal and external units, verification of volume flow (air/ hydraulic where applicable), control strategy and error history;

Upon completion of maintenance and inspection works, detailed and accurate documentation must be left with the End User, which may be required when making a warranty claim.

REPAIR PROCESS

After inspection of the system Panasonic will determine (directly or through the intervention of an authorised third party) if the defect is subject to the Warranty. In case the defect is subject to the Extended Warranty, Panasonic (through the intervention of an authorised third party) will repair the defect.

When Warranty service involves the exchange of a Product or the replacement of a part, subject to applicable law, the item exchanged or replaced becomes the property of Panasonic. If, after repeated efforts, Panasonic is unable to restore the product to good working order, at Panasonic's discretion, Panasonic may replace the Product with an identical or functionally equivalent product. The replacement may be a new or refurbished item.

Where Panasonic is required to carry out any reparation works, this will only be carried out if the environment is deemed safe to do so. Any relevant access permits, risk assessments and method statements are the responsibility of the claimant. Access equipment required must be provided by the claimant in advance of attendance. Panasonic accepts no liability for failure to provide access equipment

resulting in an aborted visit. Panasonic reserves the right to refuse to carry out site works if the installation or environment is deemed unsafe. In the event of unsafe conditions Panasonic will only re-attend site once confirmation has been received that the conditions are deemed suitably safe and reserves the right to charge for an aborted visit.

PRIVACY AND DATA PROTECTION

Any personal data relating to End Users will be used by Panasonic solely for the purpose of provision and administration of the Warranty and is in accordance with applicable UK Data Protection Laws.

MODIFICATION OF THE TERMS AND CONDITIONS

Panasonic reserves the right, acting reasonably to modify or replace these Terms and Conditions in order to:

1. Comply with law, regulations, industry guidance or codes of practice;
2. Rectify errors or ambiguities;
3. Introduce new Products or services; and
4. Reflect any other changes in the scope or nature of the Warranty;

In that case Panasonic will provide thirty (30) days' notice of any change that could have a material effect on the End User's rights or obligations and will be published online. The new terms and conditions will take effect from the date stated in the notice.

WARRANTY CLAIM PROCESS.

In case of a functional disturbance of the Product the End User shall contact the Installer who originally installed the Product, or where this may not be possible, a relevant competent servicing/ maintenance company, or contact the Panasonic technical helpline in the country of installation. Details of independent Installers of Panasonic Products and Panasonic technical helpline can be found at www.aircon.panasonic.co.uk

The Product model reference and serial number will be required and proof of purchase may also be requested. Where a serial number is not immediately available, a proof of purchase from a Distributor will be required in order to verify the serial number. Panasonic reserves the right to verify the eligibility of all claims to protect itself against fraudulent, invalid or repetitive claims.

A Warranty claim form must be fulfilled and returned to Panasonic. Failure to provide correctly completed documentation will delay the claim and Panasonic reserves the right to refuse any claim where incorrectly fulfilled documentation has been provided. Panasonic reserves the right to disqualify any claim that has been

returned to the End User or Installer that has not been returned to Panasonic within 30 days of issue.

In the event that a dispute arises, Panasonic may require access to carry out an inspection of the Product to verify the claim. Should it be determined that the failure is as a result of incorrect installation and/or selection, etc, Panasonic reserves the right to claim costs for the visit at our standard daily rate (£500.00 ex VAT). This excludes any additional costs for travel / accommodation required to attend site. A purchase order will be required in advance of attendance to cover such an event.

Panasonic accepts no cost for the diagnosis of any fault, out-of-hours work, travel or accommodation, or specialist equipment relating to a claim, or loss/ damage to any equipment used to affect a repair. Any invoices relating to successful claims must be submitted to Panasonic within 60 days of the issue. Panasonic reserves the right to reject any invoice that is received outside of this period.

LOGISTICS AND EQUIPMENT DAMAGE

Upon delivery, it is the responsibility of the Installer to inspect the Product for signs of damage. In the event that the Product packaging is deemed excessively damaged, the Installer has the right to refuse the Product. Where there is clear packaging damage, but is not deemed excessive, it is the responsibility of the Installer to carry out a more thorough inspection of the Product. Any damage must be reported immediately by phone either directly to Panasonic or via the distributor. In the event it is deemed that the damage is minor or superficial, Panasonic reserves the right to provide replacement parts to affect a repair. Where the damage is excessive, Panasonic will provide a replacement Product. In the event a direct replacement cannot be provided in a timely manner, a suitable alternative will be provided.

When making a claim, the Installer must take photos of the damage. Claims must be submitted to Panasonic within 5 working of delivery along with any relevant documentation and supporting information. Panasonic reserves the right to deny any claims made outside of this period.

From time to time a Product may be supplied that shows no clear signs of damage to the exterior packaging, but has clear signs of damage to the Product, which is discovered outside of the 5 working day period. In such an event, the Installer must provide photographic evidence of the product and packaging for review, within a maximum 30 days of delivery. Panasonic reserves the right to refuse any claims made outside of this period.

DEAD ON ARRIVAL PROCEDURE

Dead on Arrival (DOA) means equipment deemed defective at the point of installation and commissioning.

Distributor means the distributor, wholesaler or reseller through which the product is purchased.

Installer means the company carrying out the installation and/or commissioning of the product DOA Warranty claims will be processed in accordance with the following;

DOA Warranty claims will be processed in accordance with the following:

1. You must inform Panasonic directly or the Distributor (depending on the purchase route) as soon as it is believed a DOA issue has occurred and the Distributor must subsequently inform the Panasonic Technical Department either by telephone or email within 1 working day of commissioning, no greater than a 12 months from the date of sale from Panasonic. Any DOA claims made beyond this period are at the discretion of Panasonic technical team. You must provide:
 2. Full product name and serial number shall be provided at this first notification.
 3. Following notification we may wish to attend site to inspect the system and carry out any reparations required. Should access be required, a representative of the Distributor and Installer will be required to attend site at the time of the visit. Panasonic reserves to the right to refuse any claim where the parties fail to attend;
 4. Should an inspection find any failure due to incorrect selection, installation and/or commissioning, no claim will be accepted and we reserve the right to invoice you for the visit and/or repairs carried out;
 5. On acceptance of a valid DOA claim, a claim number will be issued to the distributor for completion. Completed forms must be received within 10 working days of issue. Documentary evidence may be required to support the claim, including but not limited to photos, commissioning documentation and service checker data;
 6. We reserve the right to refuse claims where insufficient evidence is provided and DOA documentation is incomplete;
 7. Where applicable, the product should be repaired on site with the relevant spare parts and components required to affect the repair. The parts will be supplied via the distributor or directly from Panasonic at the distributors request;
 8. Where a product is deemed irreparable on site or uneconomic to repair the product will be replaced. In this eventuality, the distributor must place an order for a replacement product. Once the defective product has been collected, the distributor will be recredited accordingly. In the event a direct replacement cannot be provided in a timely manner, a suitable alternative will be provided of the same value or greater, but at equal cost to the original product;
 9. Any product that is to be returned for replacement should be in good condition and show no signs of damage. The product, where possible, should be return in its original packaging. In the event that the original packaging cannot be used, efforts should be made to pack the product securely for return. Where a product is delivered on a pallet, it must be secured to a pallet ready for collection;
 10. It is the responsibility of the installer to make the product ready for collection. Panasonic accepts no liability for refusal of collection where the product has not been made available. Panasonic accepts no liability for any product lost or damage prior to collection;
 11. Payment for any site works required to affect a repair will be paid in accordance with the costs detailed within Appendix A – Warranty Repair Pricing (available upon request), at the values detailed within 'warranty Pricing'. All costs must be agreed in advance of any invoice submitted to Panasonic. DOA costs will be paid to the Distributor who will invoice Panasonic accordingly. Any DOA labour cost invoices and/or costs for spare parts supplied directly by the Distributor, must submitted to Panasonic within 30 days of the approved warranty claim. We reserve the right not to accept any costs submitted after this time.

Panasonic Aquarea A2W Commissioning Checklist Page 1 (H & J Series Only)

This commissioning Checklist is to be completed in full by the competent person who commissioned the heat pump and associated equipment as a means of demonstrating compliance with the appropriate Building Regulations and Manufactures Requirements then handed to the customer to keep for future reference.

Failure to install and commission this equipment to the manufactures instructions will invalidate the warranty, but does not affect your statutory rights.

Customers Name:

Address:

Postcode:

Heat Pump Model
(Outdoor) :

Serial Number:

Heat Pump Model
(Indoor):

Serial Number:

Cylinder Model:

Serial Number :

Coil Surface Area of Cylinder (m2):

Direct Electric Rating in Cylinder (Booster Heater) (kW)

Boiler Model (Bi-valent system)

Serial Number

Installation Company Name & Address

Postcode

OUTDOOR UNIT tick the appropriate boxes if applicable

Sited in correct, agreed location (covering planning & noise requirements)	<input type="checkbox"/>	Secured to a solid base	<input type="checkbox"/>
Is the unit installed according to manufactures clearance around unit for operation	<input type="checkbox"/>	All external pipes insulated	<input type="checkbox"/>
Has suitable consideration been made for waste water i.e. discharge on defrost	<input type="checkbox"/>	Isolator fitted by unit	<input type="checkbox"/>

Refrigeration Details (Not required for Monobloc) tick or fill out the appropriate boxes if applicable

Refrigeration Pipe length Between Indoor and Outdoor Unit _____ (m) Additional Refrigerant Charge Added (if required) _____ (grams)

Name of Qualified Refrigeration Engineer:

Company Name:

BI-VALENT (HYBRID) CONNECTION tick or fill out the appropriate boxes if applicable

Mains Gas Boiler Oil Boiler LPG Boiler Electric Heater

ELECTRICAL CONNECTION tick or fill out the appropriate boxes if applicable

Power Supply 1 Cable RCB Sized Correctly Power Supply 2 Cable and RCB Sized Correctly Isolators Fitted by Outdoor Unit

CONTROLS - SYSTEM AND HEAT PUMP tick or fill out the appropriate boxes if applicable

Automatic Bypass Fitted - Flow Rating _____ (L/min)	Low Loss Header - Flow Rating _____ (L/min)
Low Loss Header -kW Rating _____ (kW)	Volumiser Fitted (2 pipe) Volume _____ (Litres)
Buffer Tank Fitted (4 pipe) Volume _____ (Litres)	3rd Party Programmable/Timer Room Thermostat <input type="checkbox"/>
Thermostatic Radiator Valves <input type="checkbox"/>	Outdoor Ambient Air Sensor (PAW-A2W-TSOD) <input type="checkbox"/>
Buffer Tank Sensor Fitted (PAW-A2W-TSBU) <input type="checkbox"/>	Panasonic Optional Upgrade PCB Fitted (CZ-NS4P) <input type="checkbox"/>
Panasonic Room Thermistor Fitted (PAW-AW-TSRT) <input type="checkbox"/>	2 x 2 Port Valve (DHW Control) <input type="checkbox"/>
3 Port Valve (DHW Control) <input type="checkbox"/>	Plastic Pipe Size (O/D) Used On Primary Circuit _____
Copper Pipe (O/D) Size Used on Primary Circuit _____	

SYSTEM CHECK tick or fill out the appropriate boxes if applicable

The System Has Been Flushed And Cleaned In Accordance With Bs7593:2019 And Heat Pump Manufactures Water Quality Instructions Y/N:

The System Has Been Filled and Pressure tested (Y/N):

Inhibitor Make Used:

Glycol (Antifreeze) Make Used:

% of Glycol Installed into the System _____ (%)

Panasonic Aquarea A2W Commissioning Checklist Page 2

SYSTEM SET UP tick or fill out the appropriate boxes if applicable

Heating Settings Zone 1

Direct Flow Temperature Used _____ (°C)
 HIGH Flow Temperature _____ (example 55°C) Ambient Temp. Set for HIGH Flow Temp. _____ (example -3°C)
 LOW Flow Temperature _____ (example 35°C) Ambient Temp. Set for LOW Flow Temp. _____ (example +15°C)

Heating Settings Zone 2 (Heating)

Direct Flow Temperature Used _____ (°C)
 HIGH Flow Temperature _____ (example 55°C) Ambient Temp. Set for HIGH Flow Temp. _____ (example -3°C)
 LOW Flow Temperature _____ (example 35°C) Ambient Temp. Set for LOW Flow Temp. _____ (example +15°C)
 Outdoor Temperature for Heating OFF _____ (example 18°C) Outdoor Temp. for Backup Heater ON _____ (example -3°C)

Heating Settings Zone 2 (Pool)

Fixed Temperature Output for Pool Water Heating _____ (°C) Delta T Set Point in Pool Water Heating _____ (°C)

DHW Settings (If delivered by heat pump) tick or fill out the appropriate boxes if applicable

Target DHW Tank Set Temperature _____ (°C) Tank Heat up Time (max) _____ (Recommended max 60 mins)
 Tank: Re-heat temp _____ (between -2 / -12°C) Floor Operation Time (max) _____ (Recommended max 2 hours)
 Tank Heater: Internal (Backup) or External (Booster): _____ Tank Heater on Time (delay) _____

Advice: Set the maximum target set temperature for the DHW @ 7°C below the maximum flow temperature for the model installed

Sterilization settings tick or fill out the appropriate boxes if applicable

Sterilization Day _____ Sterilization Time _____ (h:m) Sterilization Temp. _____ (°C) Sterilization Duration _____ (h:m)

Backup Heater Setting tick or fill out the appropriate boxes if applicable

Room Heater (Support kW Output) _____ (On or Off) What kW Has Been Selected Active (3,6 or 9kW depending on the model) _____

Bi-Valent (Hybrid) Setting tick or fill out the appropriate boxes if applicable

Control (Alternative) Control (Parallel) Control (Advanced Parallel)
 Outdoor temperature for Bi-Valent on _____ (°C) Smart Grid Bi-Valent (J Series Only) Auto Bi-Valent (J Series Only)

SYSTEM PERFORMANCE tick or fill out the appropriate boxes if applicable

Heating Mode

Outside Ambient Temperature _____ (°C) Flow Rate _____ (L/Min)
 Water OUT Temperature _____ (°C) Water IN Temperature _____ (°C) Compressor Frequency _____ (Hz)

DHW Mode

Outside Ambient Temperature _____ (°C) Tank Target Temperature _____ (°C) Flow Rate _____ (L/Min)
 Water OUT Temperature _____ (°C) Water IN Temperature _____ (°C) Compressor Frequency _____ (Hz)

Commissioning Engineers Name: _____

Commissioning Engineers Signature: _____

Customers Name: _____

*Customers Signature: _____

Date of Commissioning: _____

*To confirm demonstration of equipment operation

Panasonic Aquarea A2W Commissioning Checklist Page 1 (H & J Series Only) - Customer Copy

This commissioning Checklist is to be completed in full by the competent person who commissioned the heat pump and associated equipment as a means of demonstrating compliance with the appropriate Building Regulations and Manufactures Requirements then handed to the customer to keep for future reference.

Failure to install and commission this equipment to the manufactures instructions will invalidate the warranty, but does not affect your statutory rights.

Customers Name:

Address:

Postcode:

Heat Pump Model
(Outdoor) :

Serial Number:

Heat Pump Model
(Indoor):

Serial Number:

Cylinder Model:

Serial Number :

Coil Surface Area of Cylinder (m2):

Direct Electric Rating in Cylinder (Booster Heater) (kW)

Boiler Model (Bi-valent system)

Serial Number

Installation Company Name & Address

Postcode

OUTDOOR UNIT tick the appropriate boxes if applicable

Sited in correct, agreed location (covering planning & noise requirements)	<input type="checkbox"/>	Secured to a solid base	<input type="checkbox"/>
Is the unit installed according to manufactures clearance around unit for operation	<input type="checkbox"/>	All external pipes insulated	<input type="checkbox"/>
Has suitable consideration been made for waste water i.e. discharge on defrost	<input type="checkbox"/>	Isolator fitted by unit	<input type="checkbox"/>

Refrigeration Details (Not required for Monobloc) tick or fill out the appropriate boxes if applicable

Refrigeration Pipe length Between Indoor and Outdoor Unit _____ (m) Additional Refrigerant Charge Added (if required) _____ (grams)

Name of Qualified Refrigeration Engineer:

Company Name:

BI-VALENT (HYBRID) CONNECTION tick or fill out the appropriate boxes if applicable

Mains Gas Boiler Oil Boiler LPG Boiler Electric Heater

ELECTRICAL CONNECTION tick or fill out the appropriate boxes if applicable

Power Supply 1 Cable RCB Sized Correctly Power Supply 2 Cable and RCB Sized Correctly Isolators Fitted by Outdoor Unit

CONTROLS - SYSTEM AND HEAT PUMP tick or fill out the appropriate boxes if applicable

Automatic Bypass Fitted - Flow Rating _____ (L/min)	Low Loss Header - Flow Rating _____ (L/min)
Low Loss Header -kW Rating _____ (kW)	Volumiser Fitted (2 pipe) Volume _____ (Litres)
Buffer Tank Fitted (4 pipe) Volume _____ (Litres)	3rd Party Programmable/Timer Room Thermostat <input type="checkbox"/>
Thermostatic Radiator Valves <input type="checkbox"/>	Outdoor Ambient Air Sensor (PAW-A2W-TSOD) <input type="checkbox"/>
Buffer Tank Sensor Fitted (PAW-A2W-TSBU) <input type="checkbox"/>	Panasonic Optional Upgrade PCB Fitted (CZ-NS4P) <input type="checkbox"/>
Panasonic Room Thermistor Fitted (PAW-AW-TSRT) <input type="checkbox"/>	2 x 2 Port Valve (DHW Control) <input type="checkbox"/>
3 Port Valve (DHW Control) <input type="checkbox"/>	Plastic Pipe Size (O/D) Used On Primary Circuit _____
Copper Pipe (O/D) Size Used on Primary Circuit _____	

SYSTEM CHECK tick or fill out the appropriate boxes if applicable

The System Has Been Flushed And Cleaned In Accordance With Bs7593:2019 And Heat Pump Manufactures Water Quality Instructions Y/N:

The System Has Been Filled and Pressure tested (Y/N):

Inhibitor Make Used:

Glycol (Antifreeze) Make Used:

% of Glycol Installed into the System _____ (%)

Panasonic Aquarea A2W Commissioning Checklist Page 2 (H & J Series Only) - Customer Copy

SYSTEM SET UP tick or fill out the appropriate boxes if applicable

Heating Settings Zone 1

Direct Flow Temperature Used _____ (°C)
 HIGH Flow Temperature _____ (example 55°C) Ambient Temp. Set for HIGH Flow Temp. _____ (example -3°C)
 LOW Flow Temperature _____ (example 35°C) Ambient Temp. Set for LOW Flow Temp. _____ (example +15°C)

Heating Settings Zone 2 (Heating)

Direct Flow Temperature Used _____ (°C)
 HIGH Flow Temperature _____ (example 55°C) Ambient Temp. Set for HIGH Flow Temp. _____ (example -3°C)
 LOW Flow Temperature _____ (example 35°C) Ambient Temp. Set for LOW Flow Temp. _____ (example +15°C)
 Outdoor Temperature for Heating OFF _____ (example 18°C) Outdoor Temp. for Backup Heater ON _____ (example -3°C)

Heating Settings Zone 2 (Pool)

Fixed Temperature Output for Pool Water Heating _____ (°C) Delta T Set Point in Pool Water Heating _____ (°C)

DHW Settings (If delivered by heat pump) tick or fill out the appropriate boxes if applicable

Target DHW Tank Set Temperature _____ (°C) Tank Heat up Time (max) _____ (Recommended max 60 mins)
 Tank: Re-heat temp _____ (between -2 / -12°C) Floor Operation Time (max) _____ (Recommended max 2 hours)
 Tank Heater: Internal (Backup) or External (Booster): _____ Tank Heater on Time (delay) _____

Advice: Set the maximum target set temperature for the DHW @ 7°C below the maximum flow temperature for the model installed

Sterilization settings tick or fill out the appropriate boxes if applicable

Sterilization Day _____ Sterilization Time _____ (h:m) Sterilization Temp. _____ (°C) Sterilization Duration _____ (h:m)

Backup Heater Setting tick or fill out the appropriate boxes if applicable

Room Heater (Support kW Output) _____ (On or Off) What kW Has Been Selected Active (3,6 or 9kW depending on the model) _____

Bi-Valent (Hybrid) Setting tick or fill out the appropriate boxes if applicable

Control (Alternative) Control (Parallel) Control (Advanced Parallel)
 Outdoor temperature for Bi-Valent on _____ (°C) Smart Grid Bi-Valent (J Series Only) Auto Bi-Valent (J Series Only)

SYSTEM PERFORMANCE tick or fill out the appropriate boxes if applicable

Heating Mode

Outside Ambient Temperature _____ (°C) Flow Rate _____ (L/Min)
 Water OUT Temperature _____ (°C) Water IN Temperature _____ (°C) Compressor Frequency _____ (Hz)

DHW Mode

Outside Ambient Temperature _____ (°C) Tank Target Temperature _____ (°C) Flow Rate _____ (L/Min)
 Water OUT Temperature _____ (°C) Water IN Temperature _____ (°C) Compressor Frequency _____ (Hz)

Commissioning Engineers Name: _____

Commissioning Engineers Signature: _____

Customers Name: _____

*Customers Signature: _____

Date of Commissioning: _____

*To confirm demonstration of equipment operation

For more information on detailed settings, view our 'How to' video tutorials:



How to check you Aquarea H Generation current flow rates

<https://www.youtube.com/watch?v=LXVK1zgaM5E>



How to check your Aquarea H Generation sensors Values including cylinder temperature and heating flow and return

<https://www.youtube.com/watch?v=0fCiyUzLqUw>



How to check your Aquarea H Generation COP to view your units efficiency

<https://www.youtube.com/watch?v=FIVoMYzkCRI>



How to set up the Aquarea H Generation heating time clock with night time set back.

https://www.youtube.com/watch?v=0_jRkLYPaRY

Panasonic®

To find out how Panasonic cares for you, log on to

www.Panasonic.co.uk/aircon

01344 85 3393 - Technical

uk-aircon-tech@eu.panasonic.co.uk

Heating & Cooling Solutions

Panasonic Appliances Air Conditioning Europe (PAPAEU)

Panasonic UK, a branch of Panasonic Marketing Europe GmbH

Maxis 2, Western Road, Bracknell, Berkshire, RG12 1RT, UK

Panasonic Ireland. A branch of Panasonic Marketing Europe GmbH

Unit 1, The Courtyard, Kilcarbery Business Park

Nangor Road, Dublin 22



Do not add or replace refrigerant other than the specified type. Manufacturer is not responsible for the damage and deterioration in safety due to usage of the other refrigerant.
The outdoor units in this catalogue contains fluorinated greenhouse gases with a GWP higher than 150.